

# SCHUTZVERGLASUNGEN

wirksam für jeden Bereich

PROTECTION GLAZING

effective for any area



MADE  
IN  
GERMANY



Pauli + Sohn



MADE  
IN  
GERMANY

# Wirksamer Hygieneschutz mit flexiblen Systemen

effective hygiene protection with flexible systems

Gesundheit ist das wertvollste Gut. In Zeiten erhöhter Ansteckung durch Viren oder Grippe-Erreger müssen Unternehmen besondere Schutzmaßnahmen treffen. Um Tröpfcheninfektionen unter Mitarbeitern und im Kundenkontakt zu vermeiden, bietet Ihnen Pauli + Sohn verschiedene Sets für einen hygienisch wirksamen Infektionsschutz an – zum Beispiel für Verkaufsschalter, Empfangstresen, Rezeptionen und Theken.

## Mobil oder fest installiert

Die flexiblen Systeme zum Schutz vor Tröpfcheninfektionen sind erhältlich als mobile Aufsteller oder fest installierte Module, mit variablen Scheibengrößen und -stärken, mit oder ohne Durchreiche und mit verschiedenen Oberflächen. Das Ganze komfortabel im Set inklusive Aufmaßblatt und Zubehör – vom Verbinder über Klemmen und Pfosten bis hin zu passenden Schrauben. Alle Systeme sind einfach zu montieren, darüber hinaus sicher, funktional und modern design. Und made in Germany – hochwertig produziert und in aller Regel zuverlässig lieferbar.

Setzen Sie mit uns auf Sicherheit am Arbeitsplatz!

## Vorteile auf einen Blick:

- Befestigungssysteme für Aufsteller und Festinstallationen (inklusive Zubehör und Aufmaßblatt)
- Sets von 1 Scheibe bis zu 3 Scheiben
- Individuelle Gestaltungsmöglichkeiten
- Große Farbauswahl bei den Beschlägen
- Sonderanfertigungen auf Anfrage
- Made in Germany – kurze Transportwege, zuverlässige Lieferung

Health is the most valuable asset. In times of increased infection by viruses or flu pathogens, companies must take special protective measures. To prevent droplet infections among employees and in customer contact, Pauli + Sohn offers you various sets for hygienically effective sneeze and cough protection - for example for sales counters, reception areas and counters.

## mobile or as a stationary installation

The flexible systems for protection against droplet infections are available as mobile stands or stationary modules - optionally with glass or acrylic glass, with variable pane sizes and thicknesses, with or without pass-through and with different surfaces. The systems are conveniently supplied as a set including a measurement sheet and accessories - from connectors, clamps and posts to corresponding screws. All systems are easy to assemble and also have a safe, functional and modern design. And made in Germany - manufactured to a high standard of quality and as a rule, reliably available.

Place your trust in us with safety at the workplace!

## advantages at a glance:

- mounting systems for free-standing and stationary installations (including accessories and measurement sheet)
- sets from 1 pane up to 3 panes
- individual design options
- wide range of colours for the hardware
- special designs on request
- made in Germany - short transport routes, reliable delivery

**Set-3078:** 1 Scheibe ohne Durchreiche | 1 panel without passthrough

MADE  
IN  
GERMANY

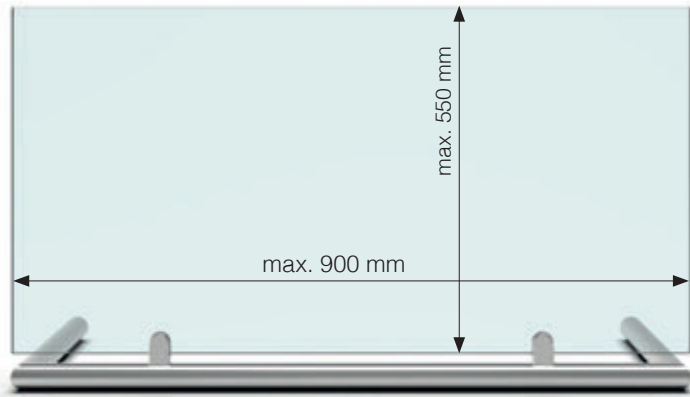

<b>Art.-Nr.</b> article no	<b>Glasdicke</b> glass thickness
Set-3078	4/6 mm*
<b>Oberfläche</b> finish	
ZN12	Alu-Optik, pulverbeschichtet Aluminium look, powder coated
ZN22	Edelstahloptik stainless steel optic
RAL	alle Farben auf Anfrage erhältlich all colors available on request

Rohr in Edelstahl matt gebürstet | tubes are brushed stainless steel

\*Bitte Glasstärke bei Bestellung angeben!  
\*Please specify glass thickness when ordering!

**Set-3079:** 1 Scheibe mit Durchreiche | 1 panel with passthrough

MADE  
IN  
GERMANY

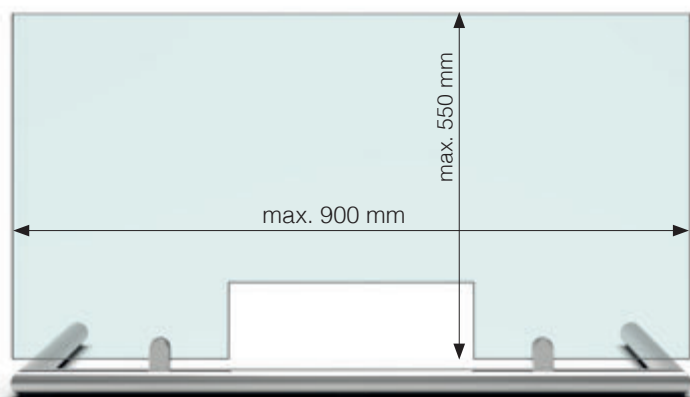

<b>Art.-Nr.</b> article no	<b>Glasdicke</b> glass thickness
Set-3079	4/6 mm*
<b>Oberfläche</b> finish	
ZN12	Alu-Optik, pulverbeschichtet Aluminium look, powder coated
ZN22	Edelstahloptik stainless steel optic
RAL	alle Farben auf Anfrage erhältlich all colors available on request

Rohr in Edelstahl matt gebürstet | tubes are brushed stainless steel

\*Bitte Glasstärke bei Bestellung angeben!  
\*Please specify glass thickness when ordering!

## Set-3077: 1 Scheibe ohne Durchreiche | 1 panel without passthrough

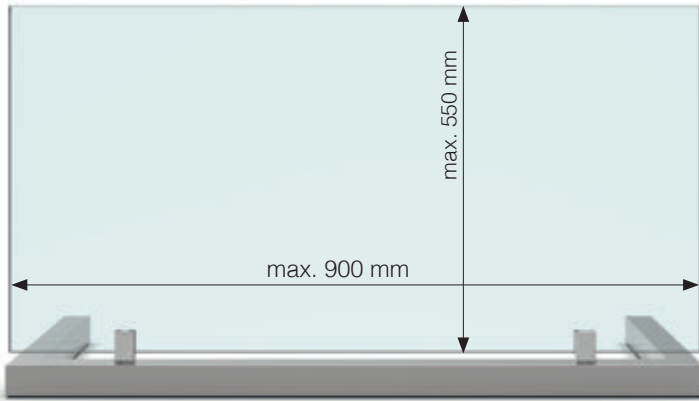

\*Bitte Glasstärke bei Bestellung angeben!  
\*Please specify glass thickness when ordering!



Art.-Nr. article no	Glasdicke glass thickness
Set-3077	4/6 mm*
Oberfläche finish	
ZN12	Alu-Optik, pulverbeschichtet Aluminium look, powder coated
ZN22	Edelstahl-optik stainless steel optic
RAL	alle Farben auf Anfrage erhältlich all colors available on request

Rohr in Edelstahl matt gebürstet | tubes are brushed stainless steel

## Set-3076: 1 Scheibe mit Durchreiche | 1 panel with passthrough

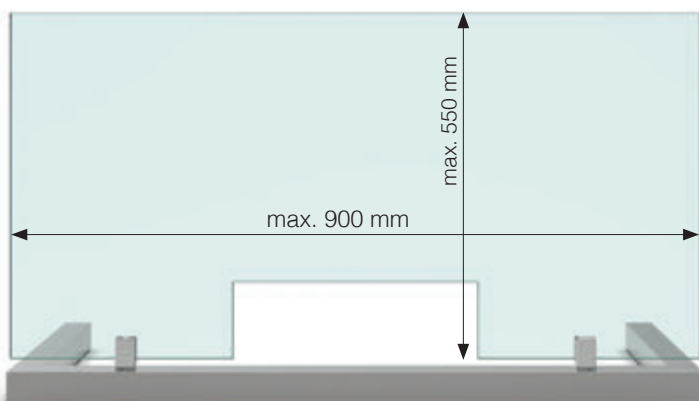

\*Bitte Glasstärke bei Bestellung angeben!  
\*Please specify glass thickness when ordering!



Art.-Nr. article no	Glasdicke glass thickness
Set-3076	4/6 mm*
Oberfläche finish	
ZN12	Alu-Optik, pulverbeschichtet Aluminium look, powder coated
ZN22	Edelstahl-optik stainless steel optic
RAL	alle Farben auf Anfrage erhältlich all colors available on request

Rohr in Edelstahl matt gebürstet | tubes are brushed stainless steel

**Set-3087: 1 Scheibe ohne Durchreiche** | 1 panel without passthrough

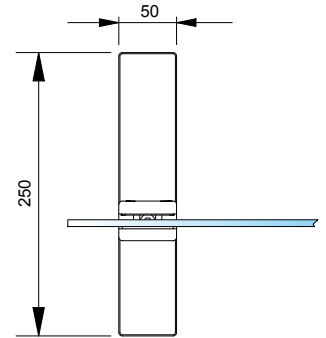
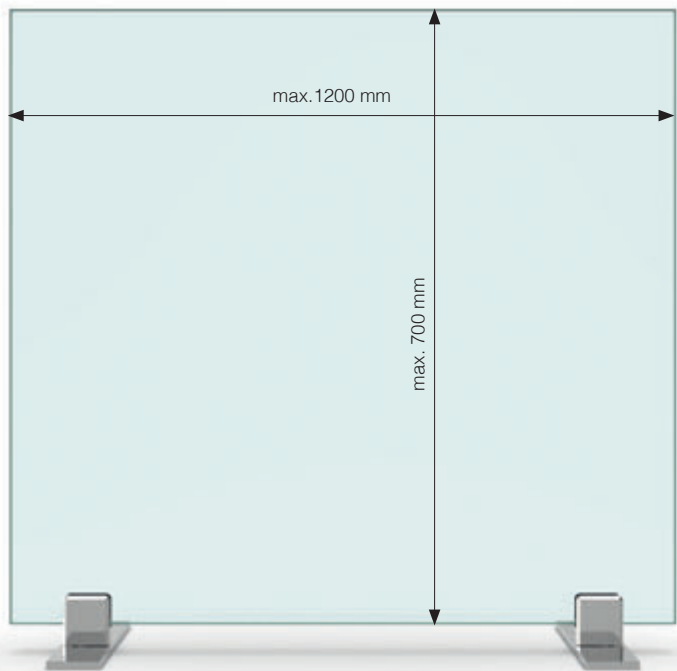

<b>Art.-Nr.</b> article no	<b>Glasdicke</b> glass thickness
Set-3087	6-12,76 mm*
<b>Oberfläche</b> finish	
ZN12	Alu-Optik, pulverbeschichtet Aluminium look, powder coated
ZN22	Edelstahloptik stainless steel optic
RAL	alle Farben auf Anfrage erhältlich all colors available on request
VA2	Edelstahl matt gebürstet stainless steel matt brushed

\*Bitte Glasstärke bei Bestellung angeben!  
\*Please specify glass thickness when ordering!

Grundplatte in Edelstahl matt gebürstet | baseplate is brushed stainless steel

**Set-3088: 1 Scheibe mit Durchreiche** | 1 panel with passthrough

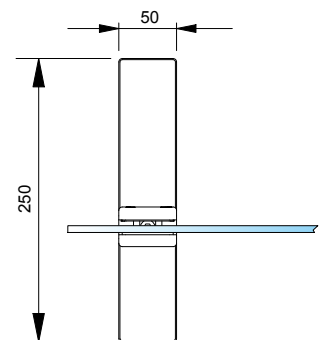
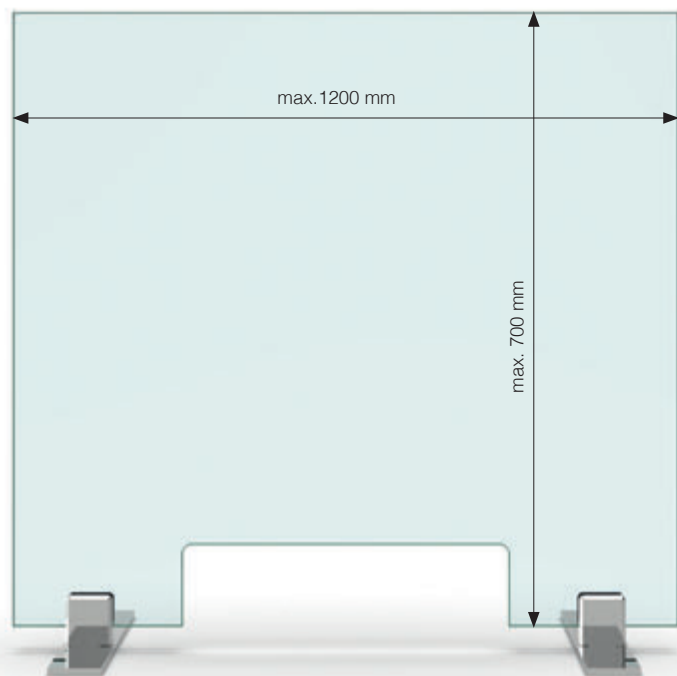

<b>Art.-Nr.</b> article no	<b>Glasdicke</b> glass thickness
Set-3088	6-12,76 mm*
<b>Oberfläche</b> finish	
ZN12	Alu-Optik, pulverbeschichtet Aluminium look, powder coated
ZN22	Edelstahloptik stainless steel optic
RAL	alle Farben auf Anfrage erhältlich all colors available on request
VA2	Edelstahl matt gebürstet stainless steel matt brushed

\*Bitte Glasstärke bei Bestellung angeben!  
\*Please specify glass thickness when ordering!

Grundplatte in Edelstahl matt gebürstet | baseplate is brushed stainless steel

**Set-3085: 1 Scheibe ohne Durchreiche** | 1 panel without pass-through

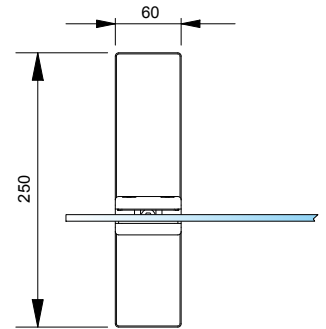
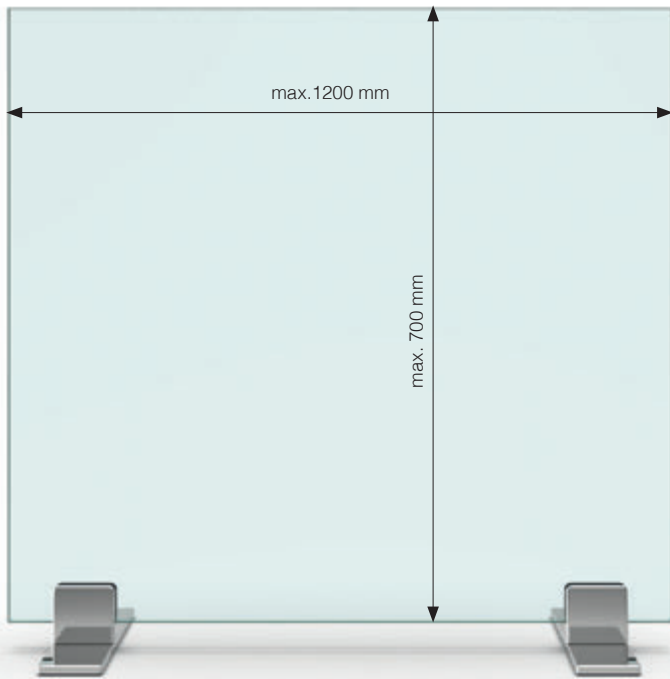

<b>Art.-Nr.</b> article no	<b>Glasdicke</b> glass thickness
Set-3085	6-12,76 mm*
<b>Oberfläche</b> finish	
ZN12	Alu-Optik, pulverbeschichtet Aluminium look, powder coated
ZN22	Edelstahloptik stainless steel optic
RAL	alle Farben auf Anfrage erhältlich all colors available on request
VA2	Edelstahl matt gebürstet stainless steel matt brushed

Grundplatte in Edelstahl matt gebürstet | baseplate is brushed stainless steel

\*Bitte Glasstärke bei Bestellung angeben!  
\*Please specify glass thickness when ordering!

**Set-3086: 1 Scheibe mit Durchreiche** | 1 panel with pass-through

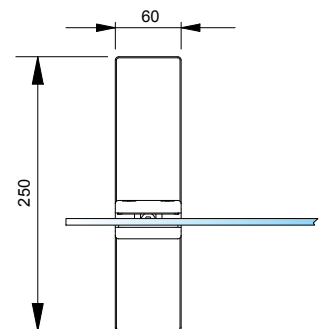
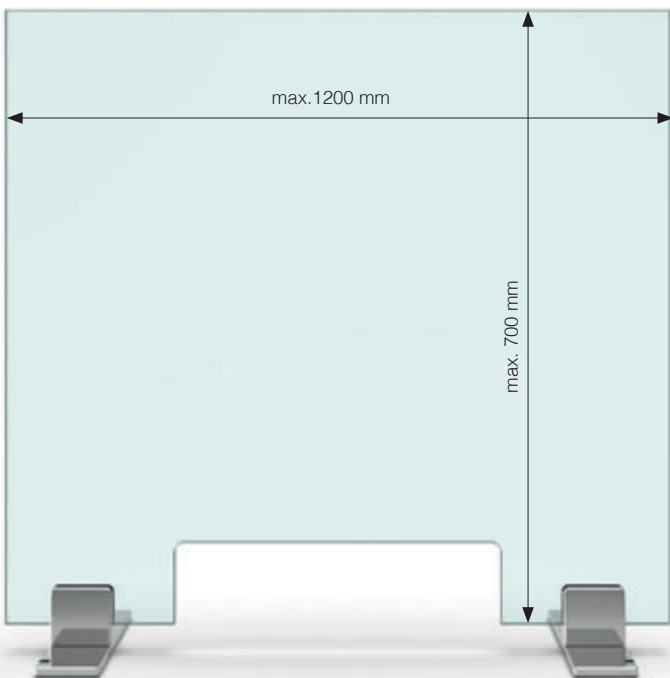

<b>Art.-Nr.</b> article no	<b>Glasdicke</b> glass thickness
Set-3086	6-12,76 mm*
<b>Oberfläche</b> finish	
ZN12	Alu-Optik, pulverbeschichtet Aluminium look, powder coated
ZN22	Edelstahloptik stainless steel optic
RAL	alle Farben auf Anfrage erhältlich all colors available on request
VA2	Edelstahl matt gebürstet stainless steel matt brushed

Grundplatte in Edelstahl matt gebürstet | baseplate is brushed stainless steel

\*Bitte Glasstärke bei Bestellung angeben!  
\*Please specify glass thickness when ordering!

**Set-3083:** 1 Scheibe ohne Durchreiche | 1 panel without pass-through

MADE  
IN  
GERMANY

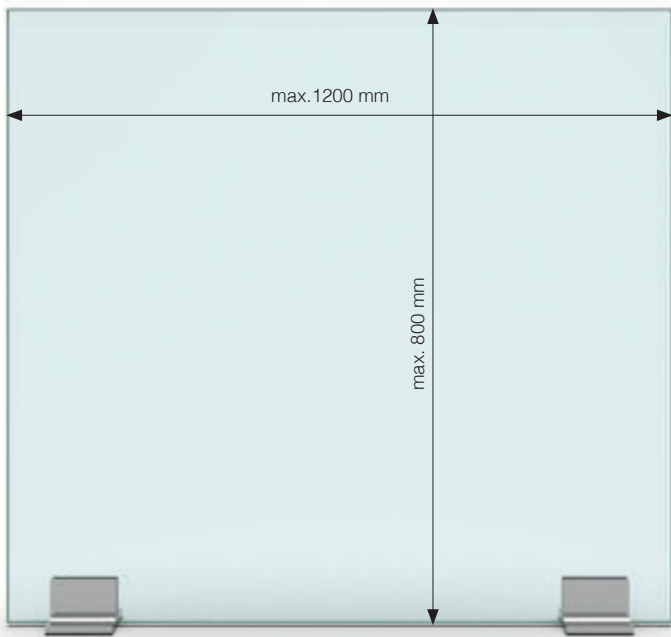

\*Bitte Glasstärke bei Bestellung angeben!  
\*Please specify glass thickness when ordering!

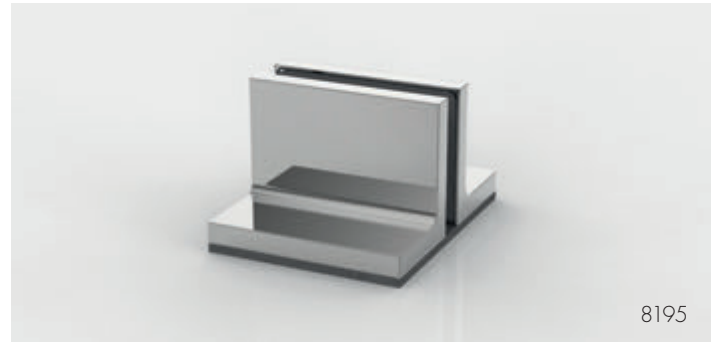

<b>Art.-Nr.</b> article no	<b>Glasdicke</b> glass thickness
Set-3083	6/8/10 mm*
<b>Oberfläche</b> finish	
ZN5	glanzverchromt gloss chrome
ZNPVD22	Edelstahloptik stainless steel optic
ZN35	schwarz black
RAL	alle Farben auf Anfrage erhältlich all colors available on request

**Set-3084:** 1 Scheibe mit Durchreiche | 1 panel with pass-through

MADE  
IN  
GERMANY

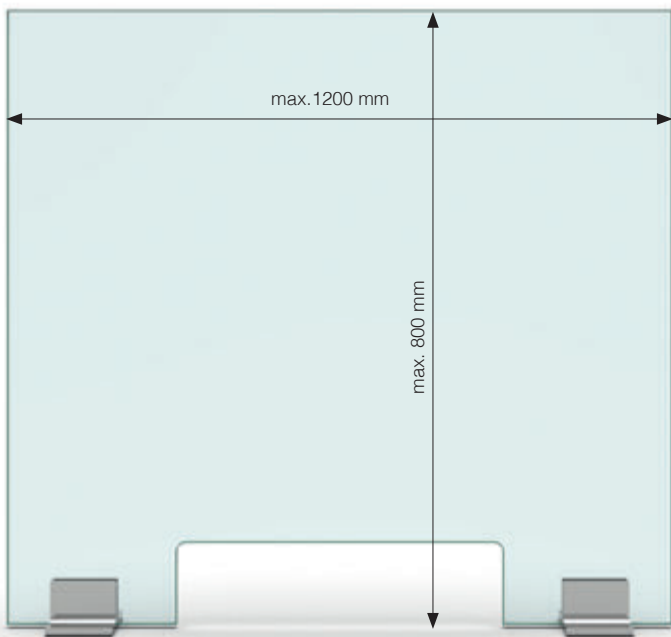

\*Bitte Glasstärke bei Bestellung angeben!  
\*Please specify glass thickness when ordering!

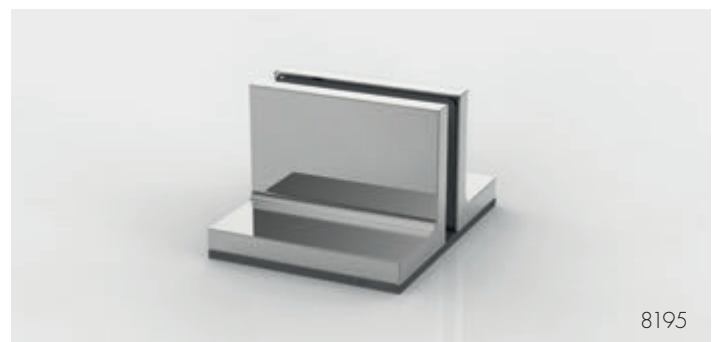

<b>Art.-Nr.</b> article no	<b>Glasdicke</b> glass thickness
Set-3084	6/8/10 mm*
<b>Oberfläche</b> finish	
ZN5	glanzverchromt gloss chrome
ZNPVD22	Edelstahloptik stainless steel optic
ZN35	schwarz black
RAL	alle Farben auf Anfrage erhältlich all colors available on request





**Set-3089:** 1 Scheibe mit Durchreiche | 1 panel with pass-through

MADE  
IN  
GERMANY

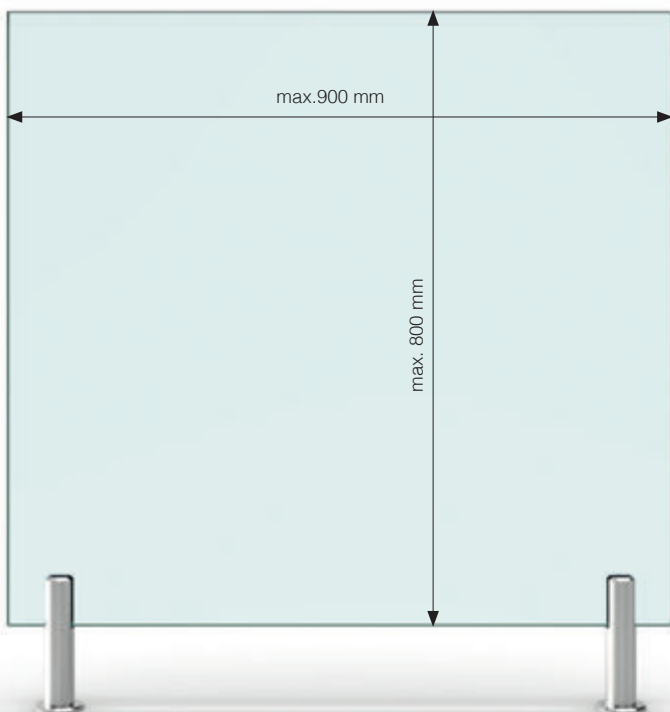

Art.-Nr. article no	Glasdicke glass thickness
Set-3089	8-12,76 mm*
Oberfläche finish	
VA	Edelstahl stainless steel

\*Bitte Glasstärke bei Bestellung angeben!  
\*Please specify glass thickness when ordering!

## Set-3074: 1 Scheibe ohne Durchreiche | 1 panel without passthrough

Lieferbar ab Sommer 2020  
available in summer 2020

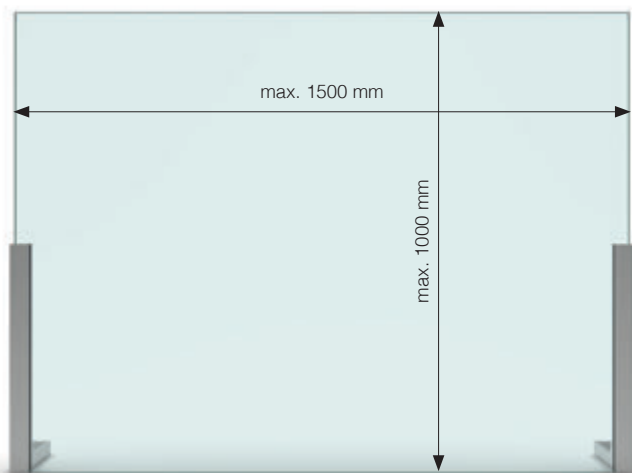

\*Bitte Glasstärke bei Bestellung angeben!  
\*Please specify glass thickness when ordering!



Art.-Nr. article no	Glasdicke glass thickness
Set-3074	6-10 mm*
Oberfläche finish	
MS7	glanzverchromt gloss chrome
MSPVD22	Edelstahloptik stainless steel optic
MS35	schwarz matt matt black
RAL	alle Farben auf Anfrage erhältlich all colors available on request

## Set-3090: 1 Scheibe mit Durchreiche | 1 panel with pass-through

Lieferbar ab Sommer 2020  
available in summer 2020

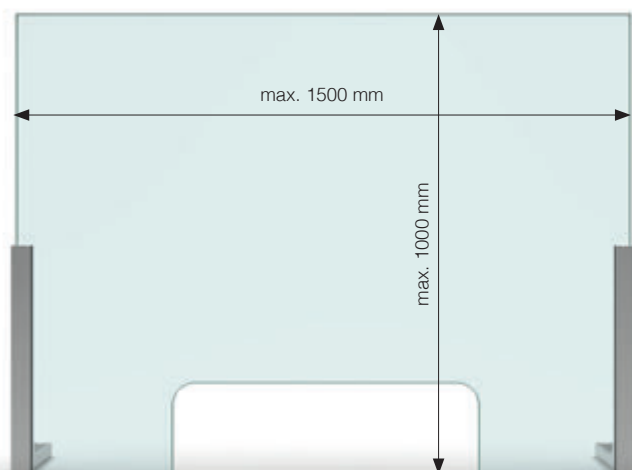

\*Bitte Glasstärke bei Bestellung angeben!  
\*Please specify glass thickness when ordering!



Art.-Nr. article no	Glasdicke glass thickness
Set-3090	6-10 mm*
Oberfläche finish	
MS7	glanzverchromt gloss chrome
MSPVD22	Edelstahloptik stainless steel optic
MS35	schwarz black
RAL	alle Farben auf Anfrage erhältlich all colors available on request



**Set-3063:** 1 Scheibe ohne Durchreiche | 1 panel without pass-through

MADE  
IN  
GERMANY

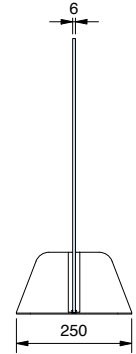
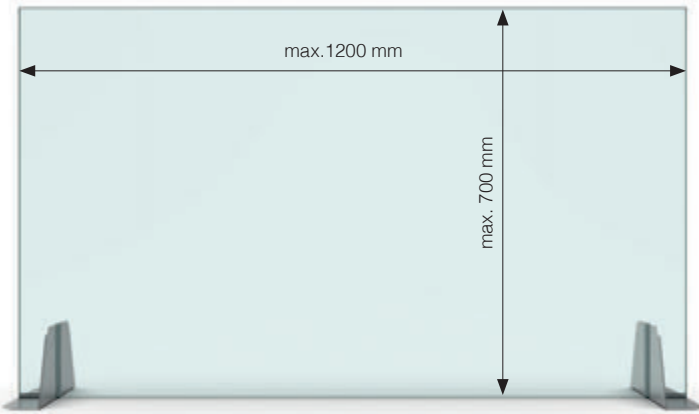

\*Bitte Glasstärke bei Bestellung angeben!  
\*Please specify glass thickness when ordering!

Art.-Nr. article no	Glasdicke glass thickness
Set-3063	6 mm*
Oberfläche finish	
VA2	Edelstahl matt gebürstet stainless steel matt brushed

**Set-3062:** 1 Scheibe mit Durchreiche | 1 panel with pass-through

MADE  
IN  
GERMANY

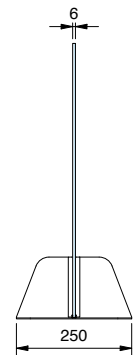
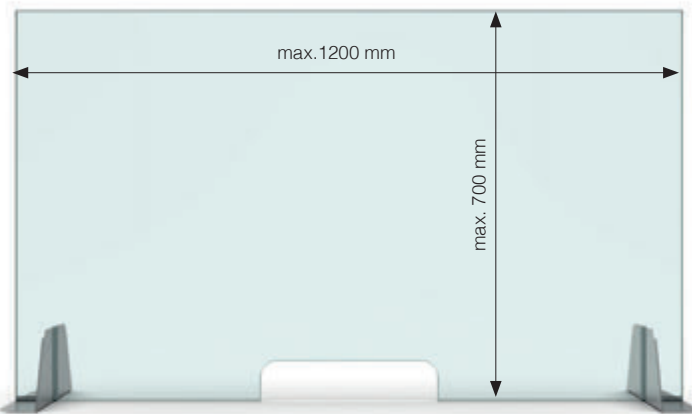

\*Bitte Glasstärke bei Bestellung angeben!  
\*Please specify glass thickness when ordering!

Art.-Nr. article no	Glasdicke glass thickness
Set-3062	6 mm*
Oberfläche finish	
VA2	Edelstahl matt gebürstet stainless steel matt brushed

**Set-3099: 2 Scheiben (90°) ohne Durchreiche** | 2 panels (90°) without pass-through

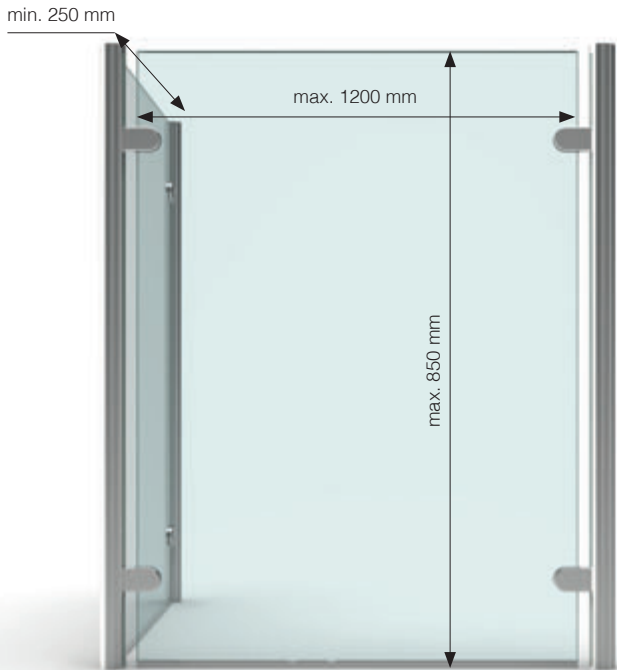

<b>Art.-Nr.</b> article no	<b>Glasdicke</b> glass thickness
Set-3099	4/6 mm*
<b>Oberfläche</b> finish	
ZN12	Alu-Optik, pulverbeschichtet Aluminium look, powder coated
ZN22	Edelstahloptik stainless steel optic
RAL	alle Farben auf Anfrage erhältlich all colors available on request

Rohr in Edelstahl matt gebürstet | tubes are brushed stainless steel

\*Bitte Glasstärke bei Bestellung angeben! U-Profile können optional mitgeliefert werden. optional: Pfosten in A2 oder A4 erhältlich  
\*Please specify glass thickness when ordering! U profiles can be supplied optionally. optional: posts are available in 304 or 316 stainless steel

**Set-3098: 3 Scheiben (90°) ohne Durchreiche** | 3 panels (90°) without pass-through

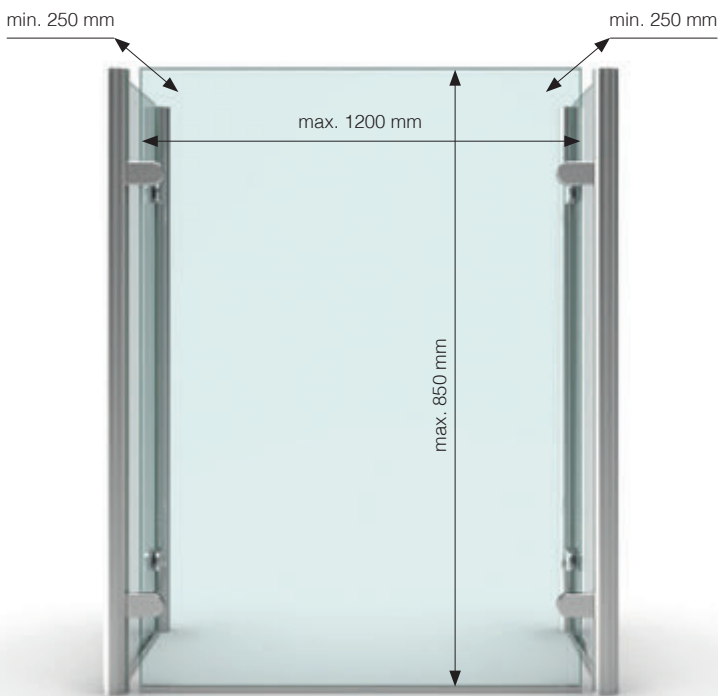

<b>Art.-Nr.</b> article no	<b>Glasdicke</b> glass thickness
Set-3098	4/6 mm*
<b>Oberfläche</b> finish	
ZN12	Alu-Optik, pulverbeschichtet Aluminium look, powder coated
ZN22	Edelstahloptik stainless steel optic
RAL	alle Farben auf Anfrage erhältlich all colors available on request

Rohr in Edelstahl matt gebürstet | tubes are brushed stainless steel

\*Bitte Glasstärke bei Bestellung angeben! U-Profile können optional mitgeliefert werden. optional: Pfosten in A2 oder A4 erhältlich  
\*Please specify glass thickness when ordering! U profiles can be supplied optionally. optional: posts are available in 304 or 316 stainless steel



## Set-3097: 2 Scheiben (90°) ohne Durchreiche | 2 panels (90°) without passthrough

MADE  
IN  
GERMANY

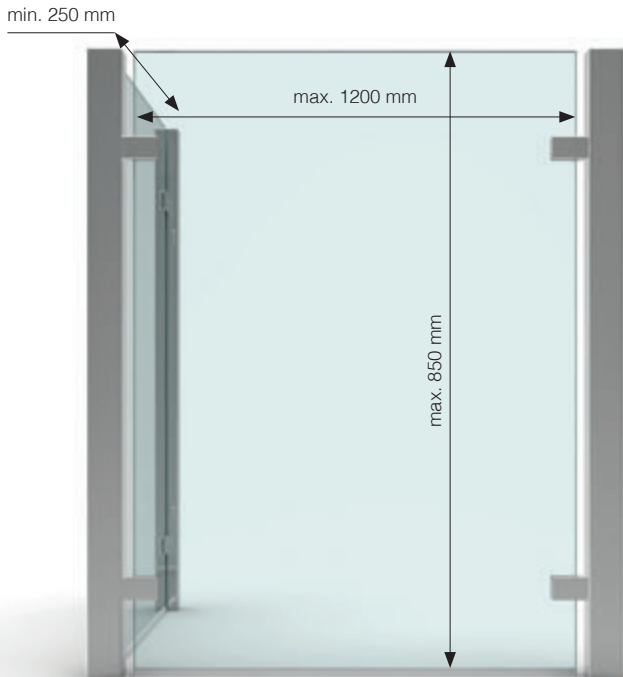

3000/3001

Art.-Nr. article no	Glasdicke glass thickness
Set-3097	4/6 mm*
Oberfläche finish	
ZN12	Alu-Optik, pulverbeschichtet Aluminium look, powder coated
ZN22	Edelstahloptik stainless steel optic
RAL	alle Farben auf Anfrage erhältlich all colors available on request

Rohr in Edelstahl matt gebürstet | tubes are brushed stainless steel

\*Bitte Glasstärke bei Bestellung angeben! U-Profile können optional mitgeliefert werden. optional: Pfosten in A2 oder A4 erhältlich  
\*Please specify glass thickness when ordering! U profiles can be supplied optionally. optional: posts are available in 304 or 316 stainless steel

## Set-3096: 3 Scheiben (90°) ohne Durchreiche | 3 panels (90°) without passthrough

MADE  
IN  
GERMANY

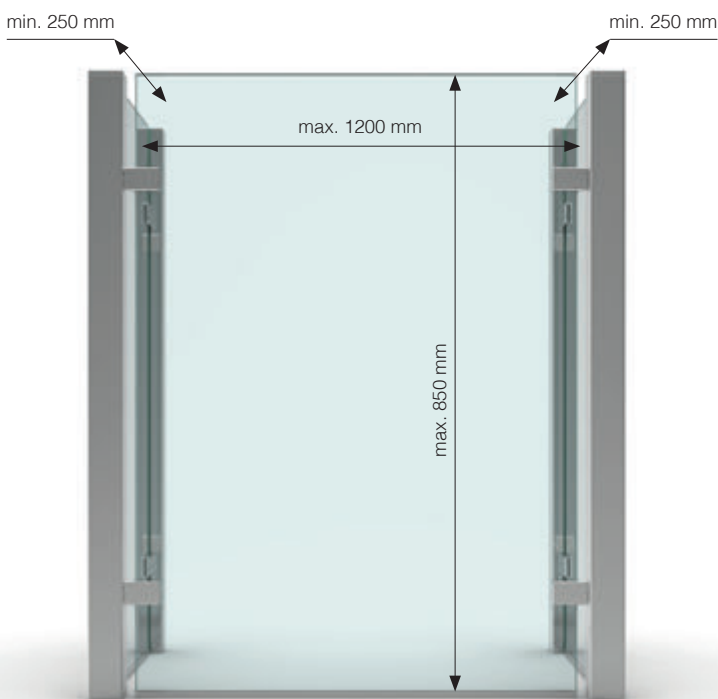

3000/3001

Art.-Nr. article no	Glasdicke glass thickness
Set-3096	4/6 mm*
Oberfläche finish	
ZN12	Alu-Optik, pulverbeschichtet Aluminium look, powder coated
ZN22	Edelstahloptik stainless steel optic
RAL	alle Farben auf Anfrage erhältlich all colors available on request

Rohr in Edelstahl matt gebürstet | tubes are brushed stainless steel

\*Bitte Glasstärke bei Bestellung angeben! U-Profile können optional mitgeliefert werden. optional: Pfosten in A2 oder A4 erhältlich  
\*Please specify glass thickness when ordering! U profiles can be supplied optionally. optional: posts are available in 304 or 316 stainless steel

**Set-3094: 2 Scheiben (90°) ohne Durchreiche | 2 panels (90°) without pass-through**



<b>Art.-Nr.</b> article no	<b>Glasdicke</b> glass thickness
Set-3094	6-10,76 mm*
<b>Oberfläche</b> finish	
VA2	Edelstahl matt gebürstet stainless steel matt brushed

\*Bitte Glasstärke bei Bestellung angeben! U-Profile können optional mitgeliefert werden.  
optional: Pfosten in A2 oder A4 erhältlich  
\*Please specify glass thickness when ordering! U profiles can be supplied optionally. optional:  
posts are available in 304 or 316 stainless steel

**Set-3095: 3 Scheiben (90°) ohne Durchreiche | 3 panels (90°) without pass-through**

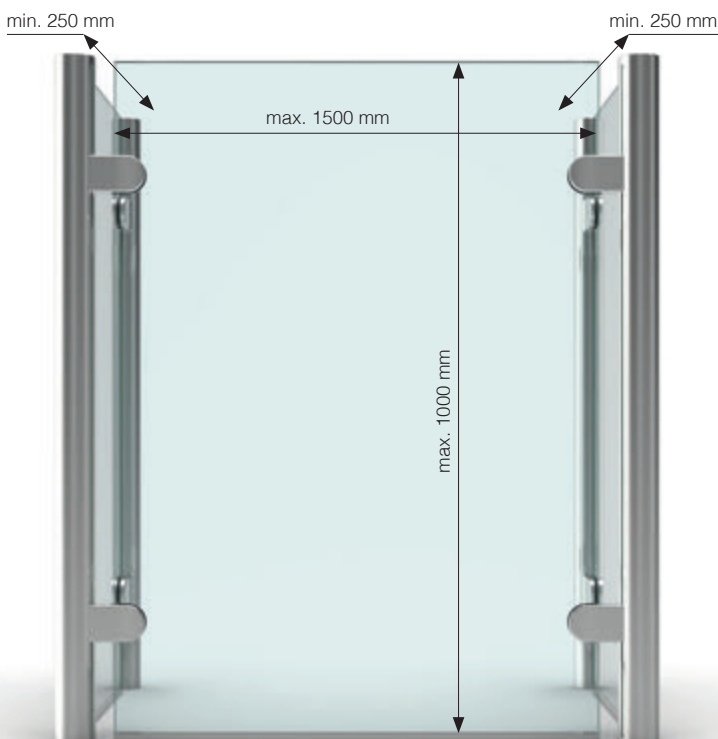

<b>Art.-Nr.</b> article no	<b>Glasdicke</b> glass thickness
Set-3095	6-10,76 mm*
<b>Oberfläche</b> finish	
VA2	Edelstahl matt gebürstet stainless steel matt brushed

\*Bitte Glasstärke bei Bestellung angeben! U-Profile können optional mitgeliefert werden.  
optional: Pfosten in A2 oder A4 erhältlich  
\*Please specify glass thickness when ordering! U profiles can be supplied optionally. optional:  
posts are available in 304 or 316 stainless steel



Zubehör für Sets mit Pfosten | accessories for sets with post



**LOCTITE® 638 Spezialkleber**  
LOCTITE® 638 Special adhesive

- Kurze Trocknung
- Hohe Festigkeit
- DVGW-geprüft
- Short bonding time
- High strength
- DVGW-Tested

**Art.-Nr.**

Art. no.

1023300CTP

1023310CTP

**Inhalt**

Content

10-ml-Flasche | 10-ml-Bottle

50-ml-Flasche | 50-ml-Bottle



**Art.-Nr.**

article no

4820VA



Sicherheitsstift für Set-3085/3086  
safety stud for Set-3085/3086

Bohrungen für Sicherungsstifte sind in den Glaszeichnungen nicht berücksichtigt, Bitte bei Bestellung erfragen.  
Holes for safety studs are not shown in the glass drawings, if desired, please enquire when ordering.

Set-3092: 3 Scheiben (90°) ohne Durchreiche | 3 panels (90°) without passthrough

MADE  
IN  
GERMANY

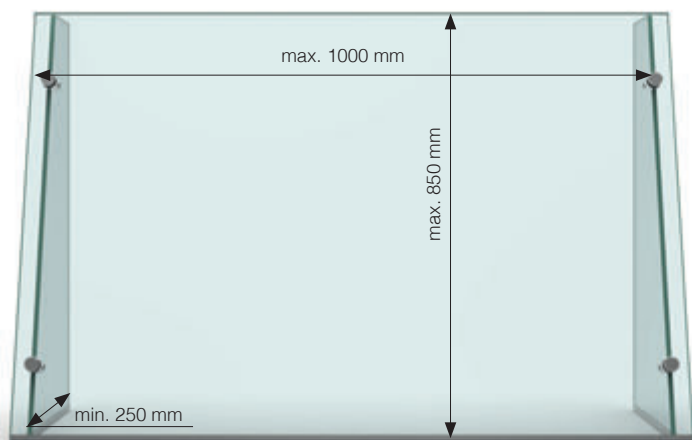

Art.-Nr. article no	Glasicke glass thickness
Set-3092	6-10 mm*
Oberfläche finish	
ZN5	glanzverchromt gloss chrome
ZN22	Edelstahloptik stainless steel optic
RAL	alle Farben auf Anfrage erhältlich all colors available on request

\*Bitte Glasstärke bei Bestellung angeben! U-Profile können optional mitgeliefert werden.  
\*Please specify glass thickness when ordering! U profiles can be supplied optionally.





**Set-3081: 3 Scheiben (135°) mit Durchreiche** | 3 panels (135°) with pass-through

MADE  
IN  
GERMANY

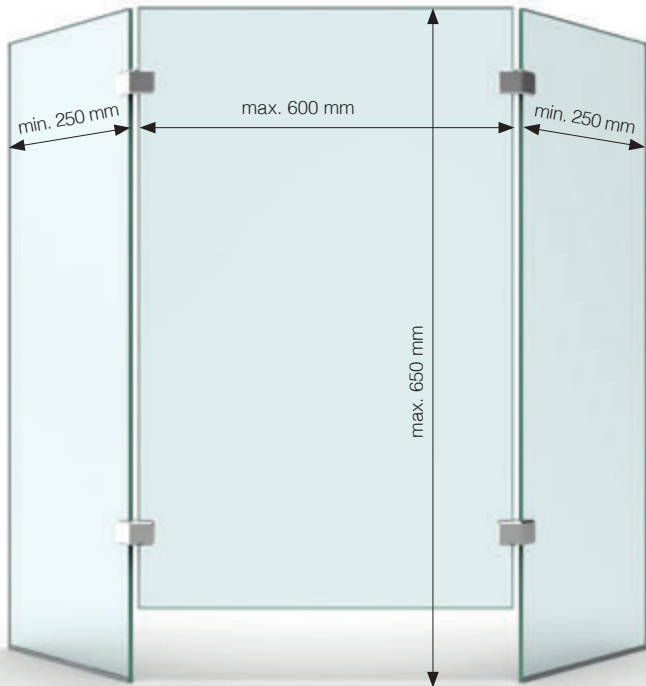

4884

Art.-Nr. article no	Glasdicke glass thickness
Set-3081	5-8 mm*
Oberfläche finish	
ZN5	glanzverchromt gloss chrome
ZN22	Edelstahloptik stainless steel optic
RAL	alle Farben auf Anfrage erhältlich all colors available on request

\*Bitte Glasstärke bei Bestellung angeben! U-Profile können optional können optional mitgeliefert werden.  
\*Please specify glass thickness when ordering! U profiles can be supplied optionally.

**Set-3082: 3 Scheiben (90°) mit Durchreiche** | 3 panels (90°) with pass-through

MADE  
IN  
GERMANY



4885

Art.-Nr. article no	Glasdicke glass thickness
Set-3082	5-8 mm*
Oberfläche finish	
ZN5	glanzverchromt gloss chrome
ZN22	Edelstahloptik stainless steel optic
RAL	alle Farben auf Anfrage erhältlich all colors available on request

\*Bitte Glasstärke bei Bestellung angeben! U-Profile können optional können optional mitgeliefert werden.  
\*Please specify glass thickness when ordering! U profiles can be supplied optionally.

**Set-3093:** 1 Scheibe mit Durchreiche | panel with passthrough

MADE  
IN  
GERMANY

Lieferbar ab Sommer 2020  
available in summer 2020

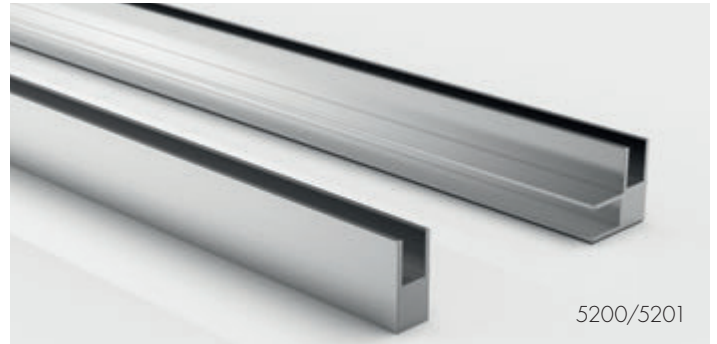
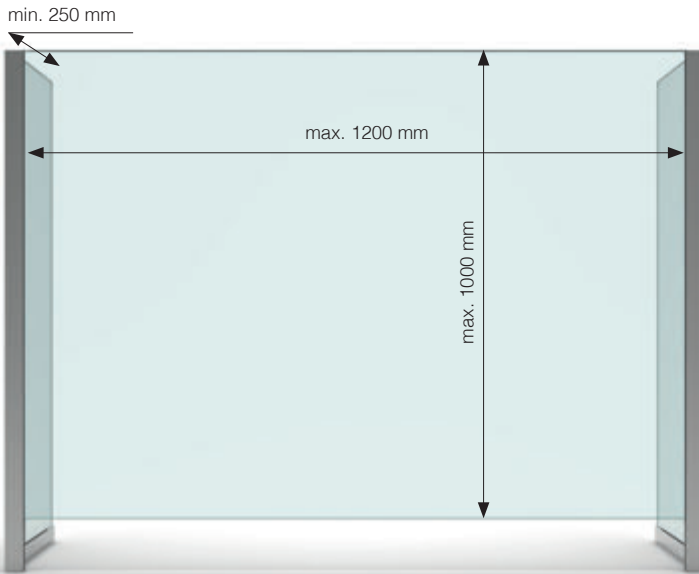

Art.-Nr. article no	Glasdicke glass thickness
Set-3093	≤ 8 mm*
Oberfläche finish	
E6EV1	Alu-Optik, silberfarbig eloxiert Aluminium look, anodised silver
RAL	alle Farben auf Anfrage erhältlich all colors available on request

\*Bitte Glasstärke bei Bestellung angeben!  
\*Please specify glass thickness when ordering!

**Set-3075:** 3 Scheiben (135°) mit Durchreiche | 3 panels (135°) with passthrough

MADE  
IN  
GERMANY

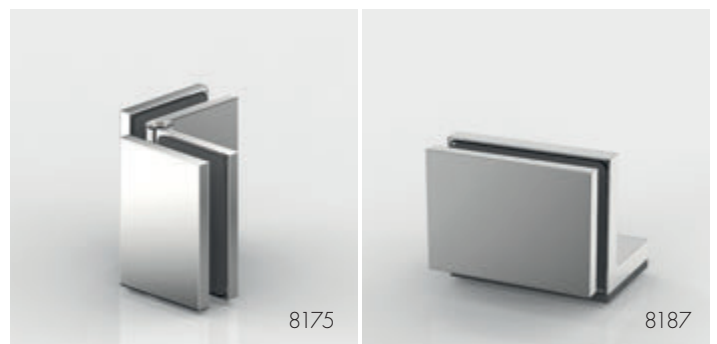
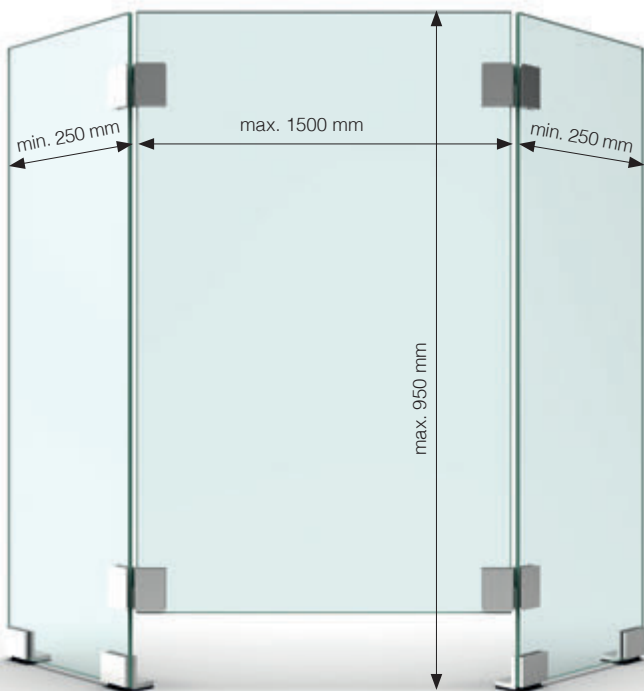

Art.-Nr. article no	Glasdicke glass thickness
Set-3075	6/8/10 mm*
Oberfläche finish	
ZN5	glanzverchromt gloss chrome
ZNPVD22	Edelstahloptik stainless steel optic
ZN35	schwarz black
RAL	alle Farben auf Anfrage erhältlich all colors available on request

\*Bitte Glasstärke bei Bestellung angeben!  
\*Please specify glass thickness when ordering!

Glasbearbeitungen | glass processing

Art.-Nr. article no	Glasdicke glass thickness
Glas-3078-V Glas zu Set-3078 glass for Set-3078	4/6 mm*

Seite | page 04

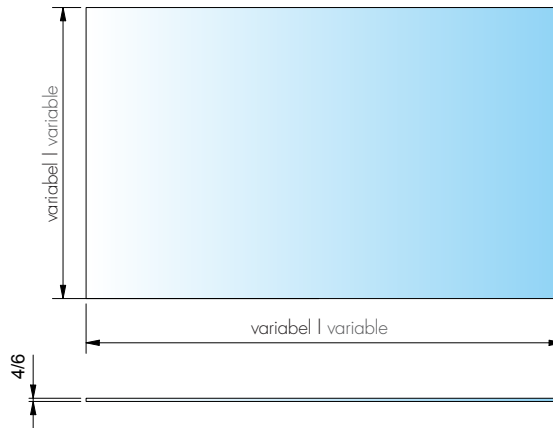

Art.-Nr. article no	Glasdicke glass thickness
Glas-3079-V Glas zu Set-3079 glass for Set-3079	4/6 mm*

Seite | page 04

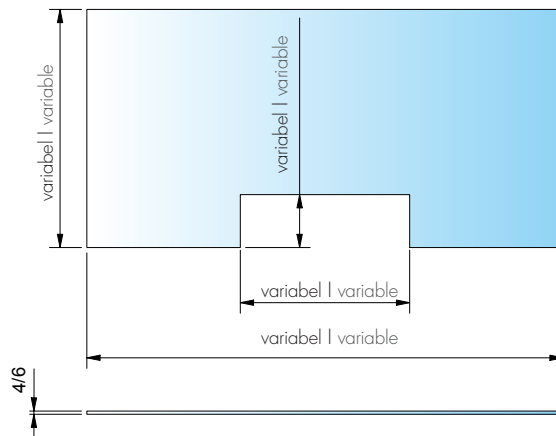

Art.-Nr. article no	Glasdicke glass thickness
Glas-3078-V Glas zu Set-3077 glass for Set-3077	4/6 mm*

Seite | page 05

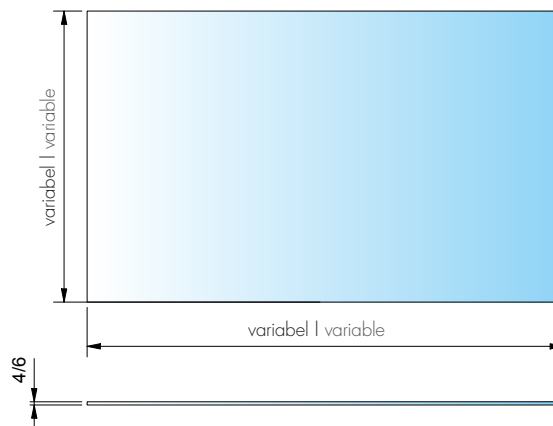

\*Bitte Glasstärke bei Bestellung angeben!  
\*Please specify glass thickness when ordering!

Glasbearbeitungen | glass processing

Art.-Nr. article no	Glasdicke glass thickness
Glas-3079-V Glas zu Set-3076 glass for Set-3076	4/6 mm*

Seite | page 05

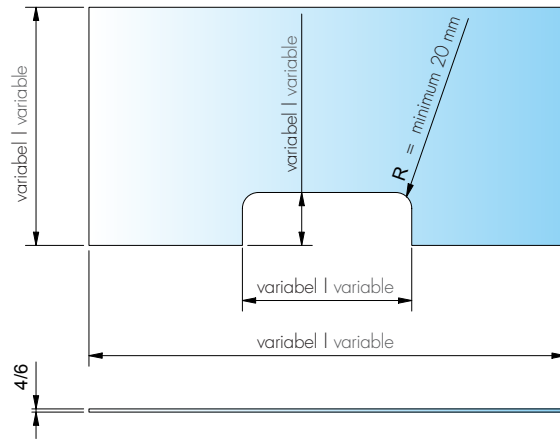

Art.-Nr. article no	Glasdicke glass thickness
Glas-3087-V Glas zu Set-3087 glass for Set-3087	6-12,76 mm*

Seite | page 06

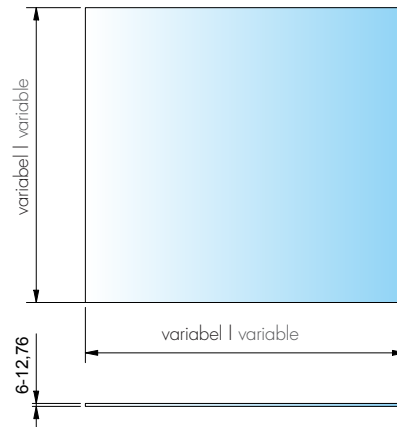

Art.-Nr. article no	Glasdicke glass thickness
Glas-3088-V Glas zu Set-3088 glass for Set-3088	6-12,76 mm*

Seite | page 06

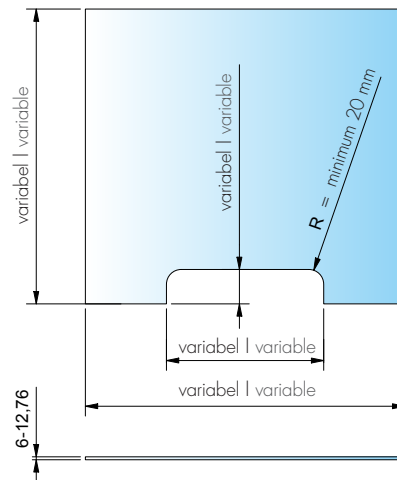

\*Bitte Glasstärke bei Bestellung angeben!  
\*Please specify glass thickness when ordering!

Glasbearbeitungen | glass processing

Art.-Nr. article no	Glasdicke glass thickness
Glas-3087-V Glas zu Set-3085 glass for Set-3085	6-12,76 mm*

Seite | page 07

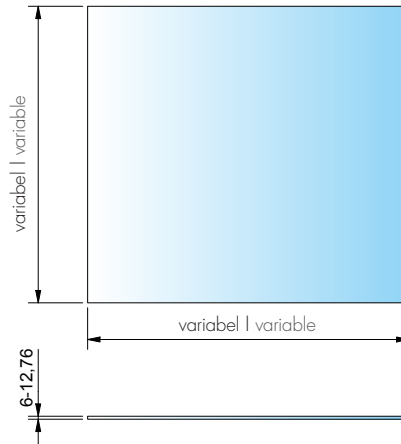

Art.-Nr. article no	Glasdicke glass thickness
Glas-3088-V Glas zu Set-3086 glass for Set-3086	6-12,76 mm*

Seite | page 07

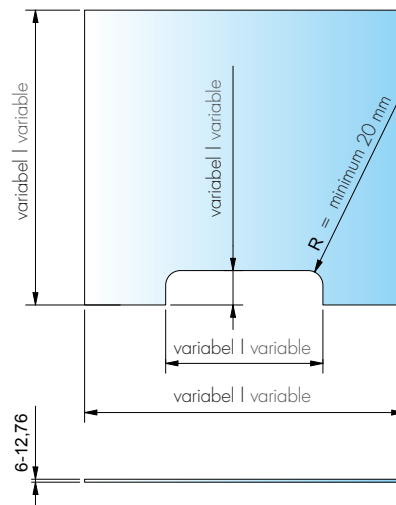

Art.-Nr. article no	Glasdicke glass thickness
Glas-3083-V Glas zu Set-3083 glass for Set-3083	6/8/10 mm*

Seite | page 08

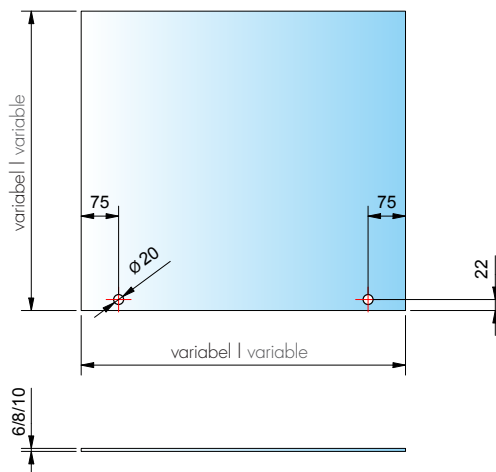

\*Bitte Glasstärke bei Bestellung angeben!  
\*Please specify glass thickness when ordering!

Glasbearbeitungen | glass processing

Art.-Nr. article no	Glasdicke glass thickness
Glas-3084-V Glas zu Set-3084 glass for Set-3084	6/8/10 mm*

Seite | page 08

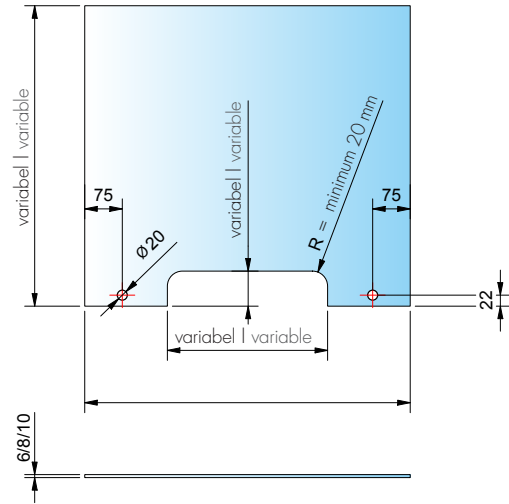

Art.-Nr. article no	Glasdicke glass thickness
Glas-3089-V Glas zu Set-3089 glass for Set-3089	8-12,76 mm*

Seite | page 09

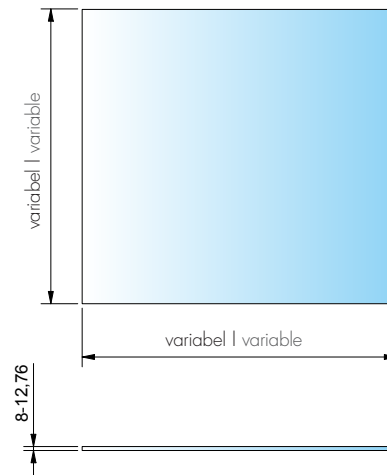

Art.-Nr. article no	Glasdicke glass thickness
Glas-3074-V Glas zu Set-3074 glass for Set-3074	6-10 mm*

Seite | page 10

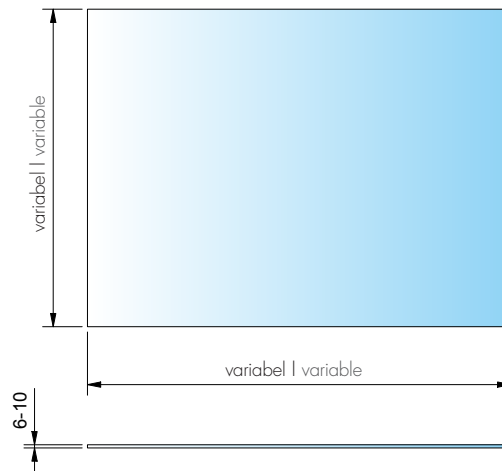

\*Bitte Glasstärke bei Bestellung angeben!  
\*Please specify glass thickness when ordering!

Glasbearbeitungen | glass processing

Art.-Nr. article no	Glasdicke glass thickness
Glas-3090-V Glas zu Set-3090 glass for Set-3090	6-10 mm*

Seite | page 10

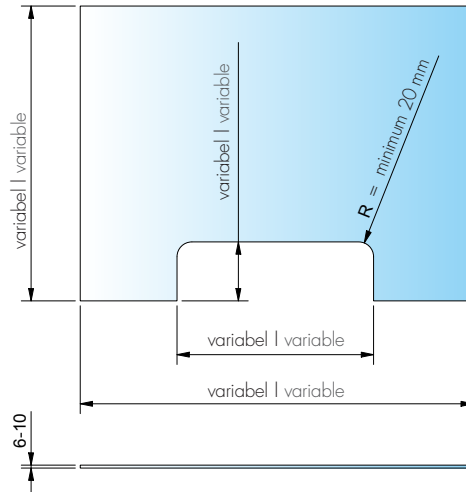

Art.-Nr. article no	Glasdicke glass thickness
Glas-3063-V Glas zu Set-3063 glass for Set-3063	6 mm*

Seite | page 11

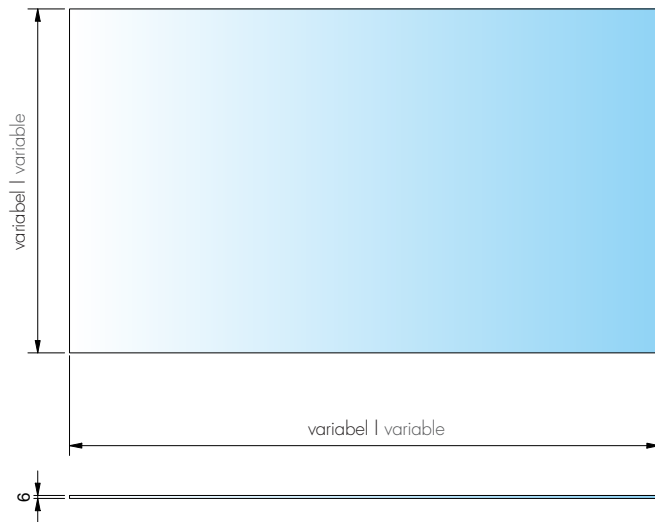

Art.-Nr. article no	Glasdicke glass thickness
Glas-3062-V Glas zu Set-3062 glass for Set-3062	6 mm*

Seite | page 11

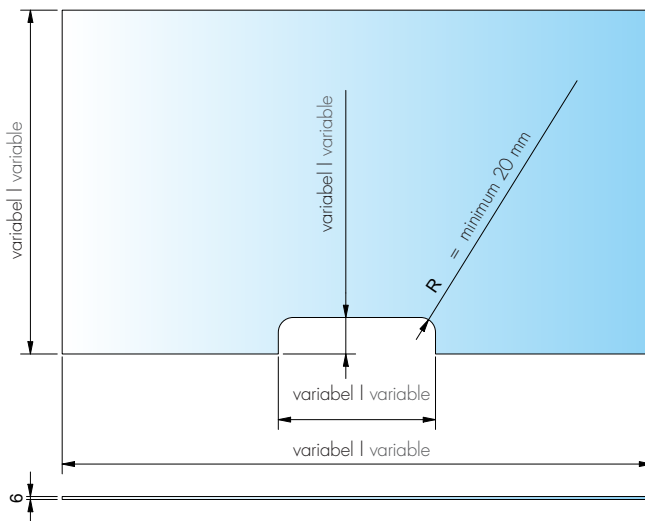

\*Bitte Glasstärke bei Bestellung angeben!  
\*Please specify glass thickness when ordering!

Glasbearbeitungen | glass processing

Art.-Nr. article no	Glasdicke glass thickness
Glas-3098-1-V Glas zu Set-3098	4/6 mm*
Glas-3098-2-V glass for Set-3098	

Seite | page 12

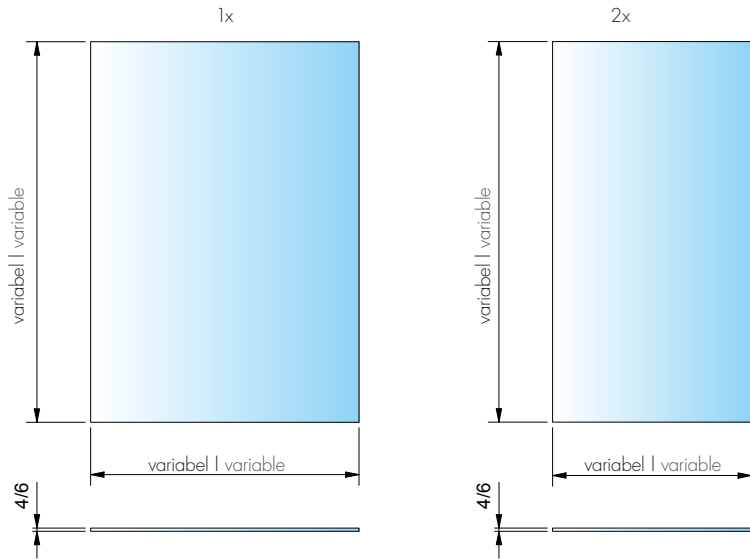

Art.-Nr. article no	Glasdicke glass thickness
Glas-3098-1-V Glas zu Set-3099	4/6 mm*
Glas-3098-2-V glass for Set-3099	

Seite | page 12

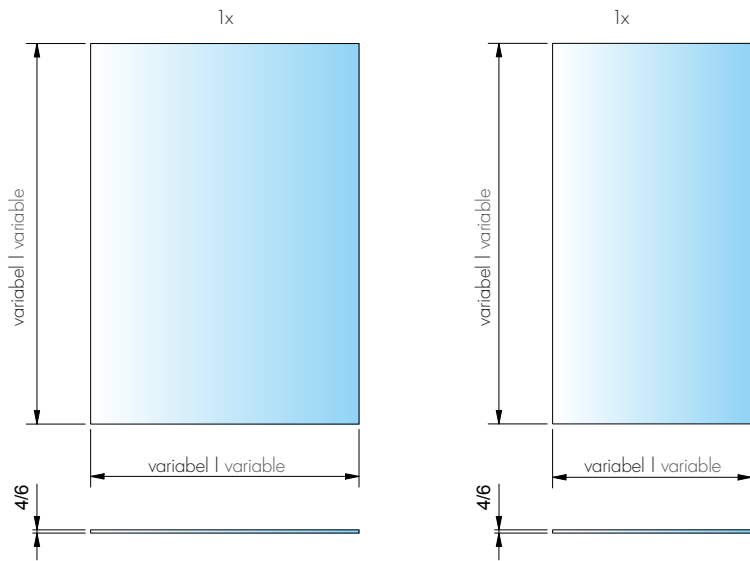

Art.-Nr. article no	Glasdicke glass thickness
Glas-3098-1-V Glas zu Set-3096	4/6 mm*
Glas-3098-2-V glass for Set-3096	

Seite | page 13

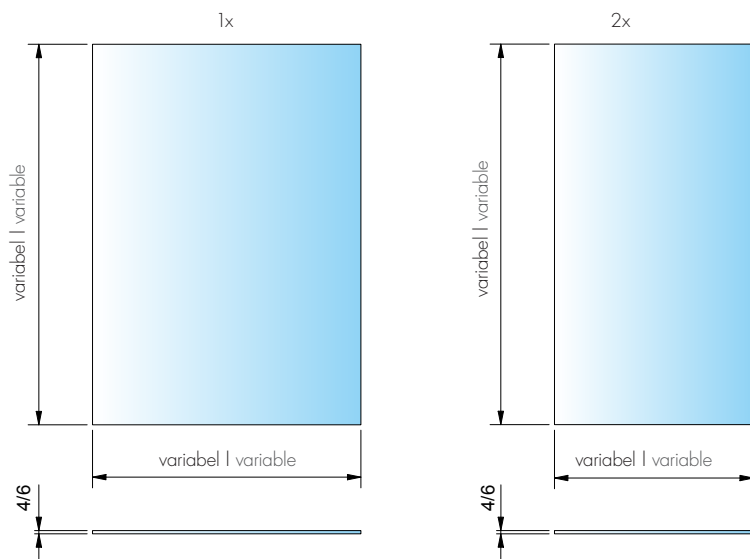

\*Bitte Glasstärke bei Bestellung angeben!  
\*Please specify glass thickness when ordering!



Glasbearbeitungen | glass processing

Art.-Nr. article no	Glasdicke glass thickness
Glas-3098-1-V Glas-3098-2-V	Glas zu Set-3097 glass for Set-3097
	4/6 mm*

Seite | page 13

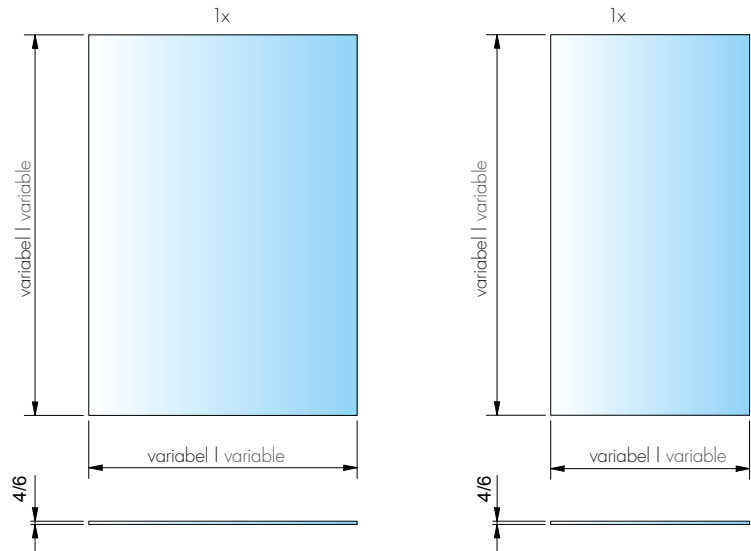

Art.-Nr. article no	Glasdicke glass thickness
Glas-3094-1-V Glas-3094-2-V	Glas zu Set-3094 glass for Set-3094
	6-10,76 mm*

Seite | page 14

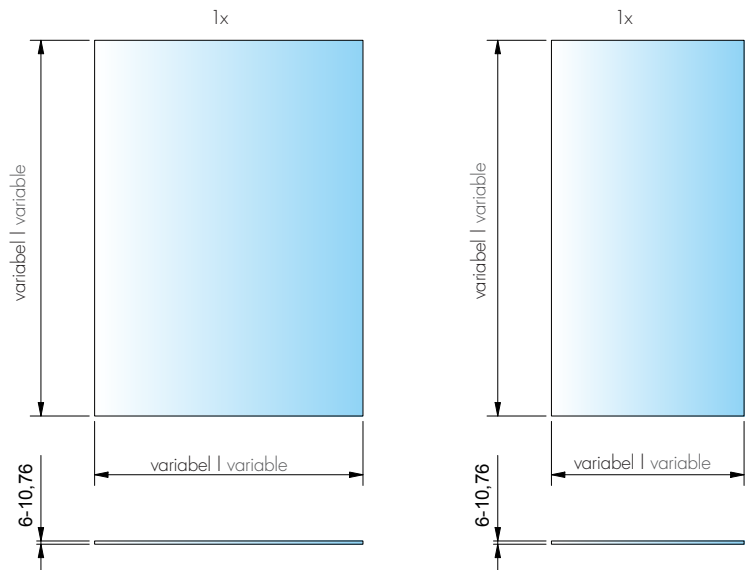

Art.-Nr. article no	Glasdicke glass thickness
Glas-3094-1-V Glas-3094-2-V	Glas zu Set-3095 glass for Set-3095
	6-10,76 mm*

Seite | page 14

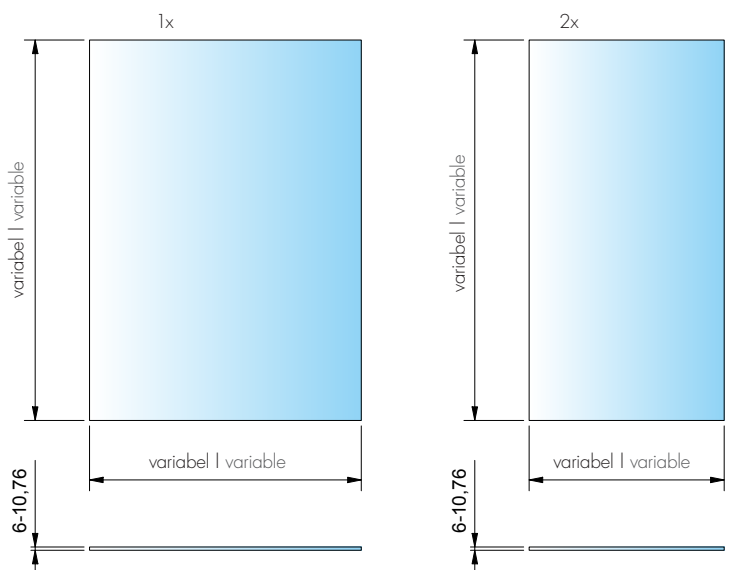

\*Bitte Glasstärke bei Bestellung angeben!  
\*Please specify glass thickness when ordering!

Glasbearbeitungen | glass processing

Art.-Nr. article no	Glasdicke glass thickness
Glas-3092-1-V Glas zu Set-3092	6-10 mm*
Glas-3092-2-V glass for Set-3092	

Seite | page 16

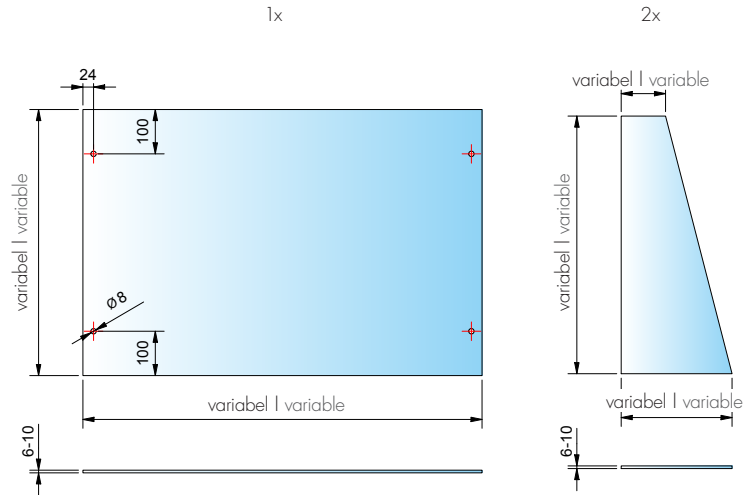

Art.-Nr. article no	Glasdicke glass thickness
Glas-3081-1-V Glas zu Set-3081	5-8 mm*
Glas-3081-2-V glass for Set-3081	

Seite | page 17

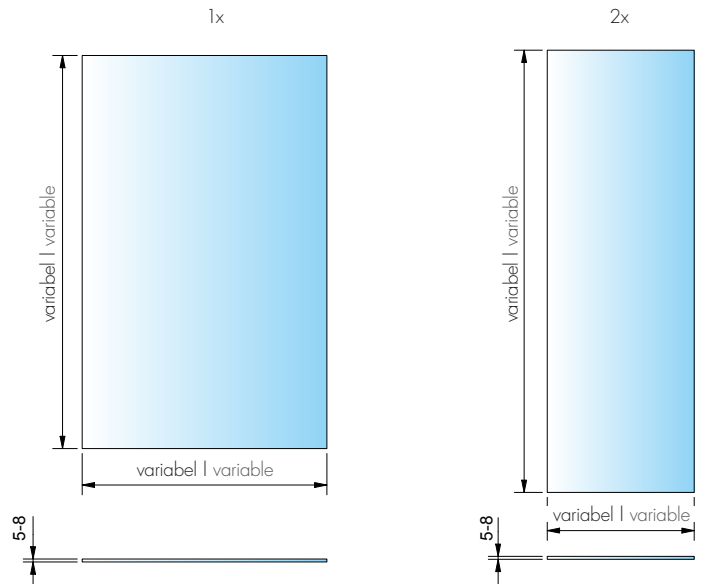

Art.-Nr. article no	Glasdicke glass thickness
Glas-3081-1-V Glas zu Set-3082	5-8 mm*
Glas-3081-2-V glass for Set-3082	

Seite | page 17

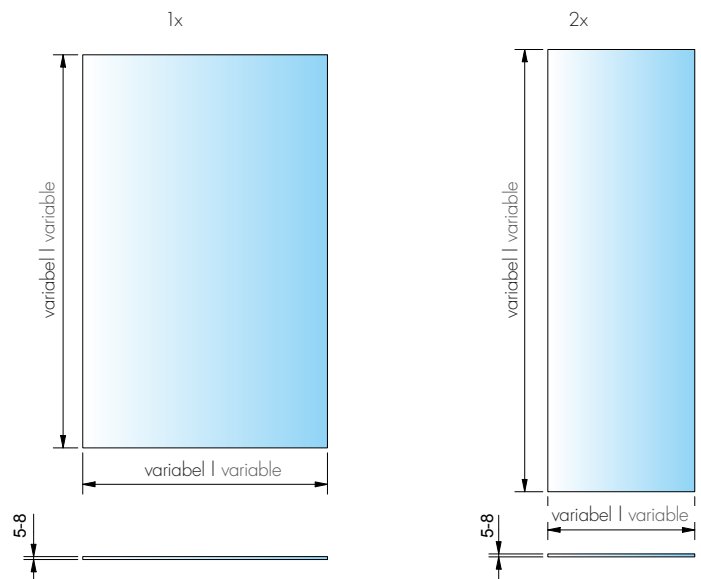

\*Bitte Glasstärke bei Bestellung angeben!  
\*Please specify glass thickness when ordering!

Glasbearbeitungen | glass processing

Art.-Nr. article no	Glasdicke glass thickness
Glas-3093-1-V Glas-3093-2-V	Glas zu Set-3093 glass for Set-3093
	≤ 8 mm*

Seite | page 18

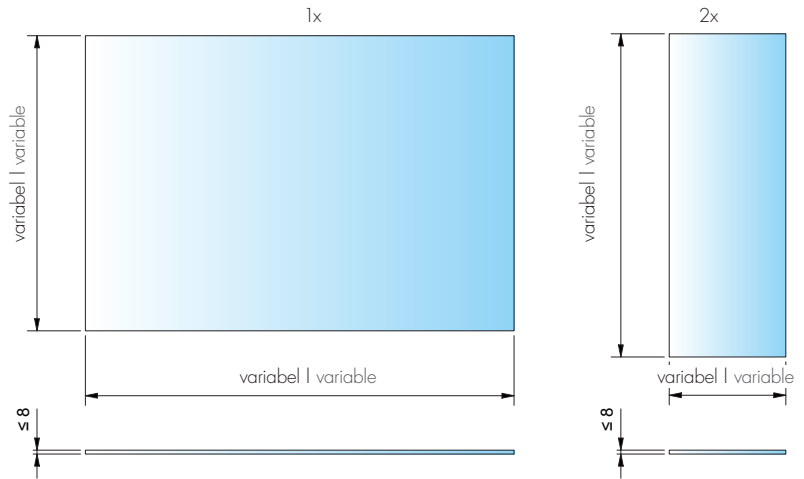

Art.-Nr. article no	Glasdicke glass thickness
Glas-3075-1-V Glas-3075-2-V	Glas zu Set-3075 glass for Set-3075
	6/8/10 mm*

Seite | page 18

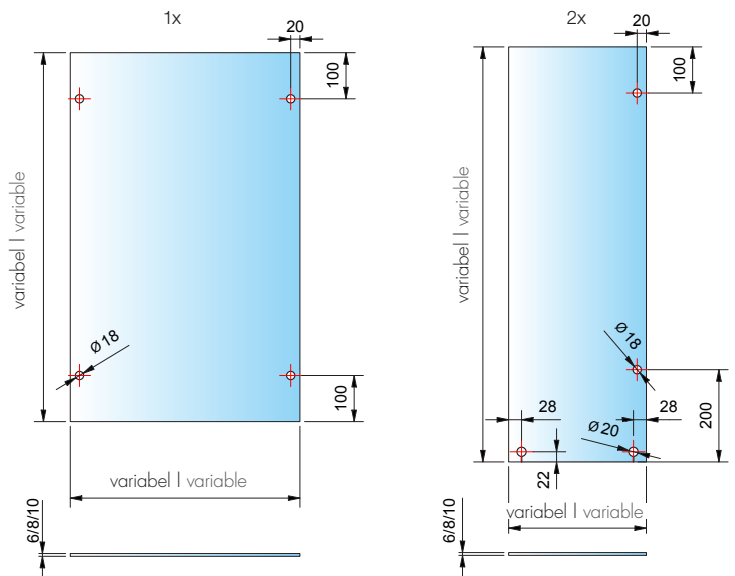

Unser Partner:



**Pauli + Sohn GmbH**

Eisenstraße 2

D-51545 Waldbröl

Telefon: +49 (0) 22 91-92 06-0

Fax: +49 (0) 22 91-92 06-681

[www.pauli.de](http://www.pauli.de)

[info@pauli.de](mailto:info@pauli.de)