

# SCHUTZVERGLASUNGEN

TEIL 1

wirksam für jeden Bereich

PROTECTION GLAZING

effective for any area



MADE  
IN  
GERMANY



Stark in Glas

 GLASBAU  
HECKMANN  
NACHFOLGER GMBH



■ MADE  
■ IN  
■ GERMANY

# Wirksamer Hygieneschutz mit flexiblen Systemen

effective hygiene protection with flexible systems

Gesundheit ist das wertvollste Gut. In Zeiten erhöhter Ansteckung durch Viren oder Grippe-Erreger müssen Unternehmen besondere Schutzmaßnahmen treffen. Um Tröpfcheninfektionen unter Mitarbeitern und im Kundenkontakt zu vermeiden, bietet Ihnen Pauli + Sohn verschiedene Sets für einen hygienisch wirksamen Infektionsschutz an – zum Beispiel für Verkaufsschalter, Empfangstresen, Rezeptionen und Theken.

## Mobil oder fest installiert

Die flexiblen Systeme zum Schutz vor Tröpfcheninfektionen sind erhältlich als mobile Aufsteller oder fest installierte Module, mit variablen Scheibengrößen und -stärken, mit oder ohne Durchreiche und mit verschiedenen Oberflächen. Das Ganze komfortabel im Set inklusive Aufmaßblatt und Zubehör – vom Verbinder über Klemmen und Pfosten bis hin zu passenden Schrauben. Alle Systeme sind einfach zu montieren, darüber hinaus sicher, funktional und modern designt. Und made in Germany – hochwertig produziert und in aller Regel zuverlässig lieferbar.

Setzen Sie mit uns auf Sicherheit am Arbeitsplatz!

## Vorteile auf einen Blick:

- Befestigungssysteme für Aufsteller und Festinstallationen (inklusive Zubehör und Aufmaßblatt)
- Sets von 1 Scheibe bis zu 3 Scheiben
- Individuelle Gestaltungsmöglichkeiten
- Große Farbauswahl bei den Beschlägen
- Sonderanfertigungen auf Anfrage
- Made in Germany – kurze Transportwege, zuverlässige Lieferung

Health is the most valuable asset. In times of increased infection by viruses or flu pathogens, companies must take special protective measures. To prevent droplet infections among employees and in customer contact, Pauli + Sohn offers you various sets for hygienically effective sneeze and cough protection - for example for sales counters, reception areas and counters.

## mobile or as a stationary installation

The flexible systems for protection against droplet infections are available as mobile stands or stationary modules - optionally with glass or acrylic glass, with variable pane sizes and thicknesses, with or without pass-through and with different surfaces. The systems are conveniently supplied as a set including a measurement sheet and accessories - from connectors, clamps and posts to corresponding screws. All systems are easy to assemble and also have a safe, functional and modern design. And made in Germany - manufactured to a high standard of quality and as a rule, reliably available.

Place your trust in us with safety at the workplace!

## advantages at a glance:

- mounting systems for free-standing and stationary installations (including accessories and measurement sheet)
- sets from 1 pane up to 3 panes
- individual design options
- wide range of colours for the hardware
- special designs on request
- made in Germany - short transport routes, reliable delivery

**Set-3078:** 1 Scheibe ohne Durchreiche | 1 panel without pass-through

MADE  
IN  
GERMANY

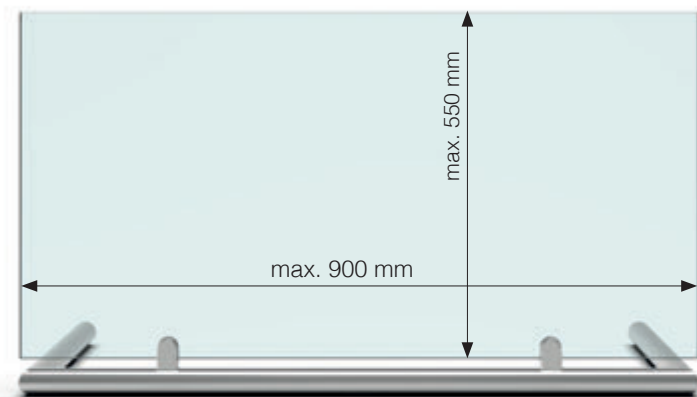

\*Bitte Glasstärke bei Bestellung angeben!  
\*Please specify glass thickness when ordering!



Art.-Nr. article no	Glasdicke glass thickness
Set-3078	4/6 mm*
Oberfläche finish	
ZN12	Alu-Optik, pulverbeschichtet Aluminium look, powder coated
ZN22	Edelstahloptik stainless steel optic
RAL	alle Farben auf Anfrage erhältlich all colors available on request

Rohr in Edelstahl matt gebürstet | tubes are brushed stainless steel

**Set-3079:** 1 Scheibe mit Durchreiche | 1 panel with pass-through

MADE  
IN  
GERMANY

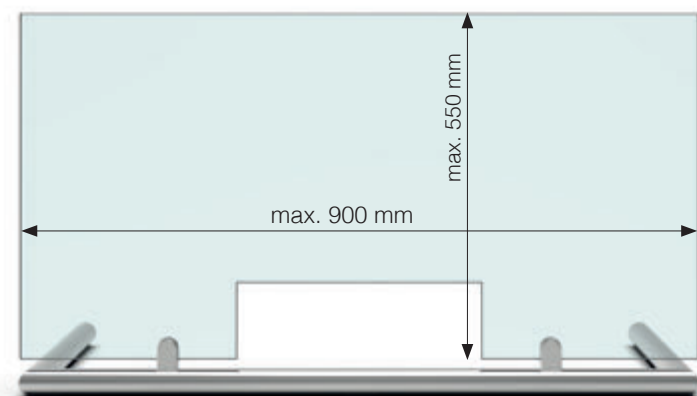

\*Bitte Glasstärke bei Bestellung angeben!  
\*Please specify glass thickness when ordering!



Art.-Nr. article no	Glasdicke glass thickness
Set-3079	4/6 mm*
Oberfläche finish	
ZN12	Alu-Optik, pulverbeschichtet Aluminium look, powder coated
ZN22	Edelstahloptik stainless steel optic
RAL	alle Farben auf Anfrage erhältlich all colors available on request

Rohr in Edelstahl matt gebürstet | tubes are brushed stainless steel

**Set-3077:** 1 Scheibe ohne Durchreiche | 1 panel without pass-through

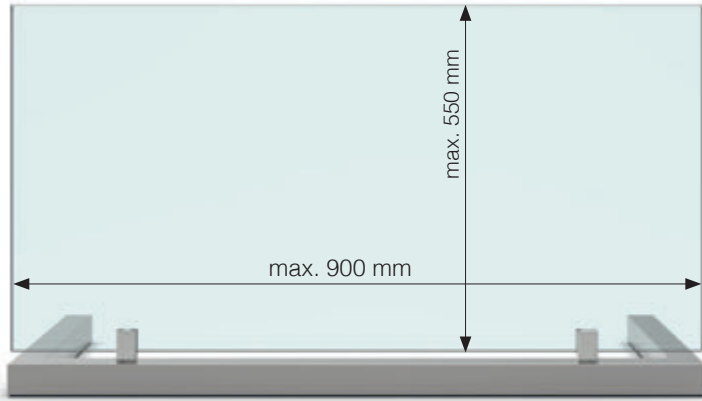

\*Bitte Glasstärke bei Bestellung angeben!  
\*Please specify glass thickness when ordering!



Art.-Nr. article no	Glasdicke glass thickness
Set-3077	4/6 mm*
Oberfläche finish	
ZN12	Alu-Optik, pulverbeschichtet Aluminium look, powder coated
ZN22	Edelstahl-optik stainless steel optic
RAL	alle Farben auf Anfrage erhältlich all colors available on request

Rohr in Edelstahl matt gebürstet | tubes are brushed stainless steel

**Set-3076:** 1 Scheibe mit Durchreiche | 1 panel with pass-through

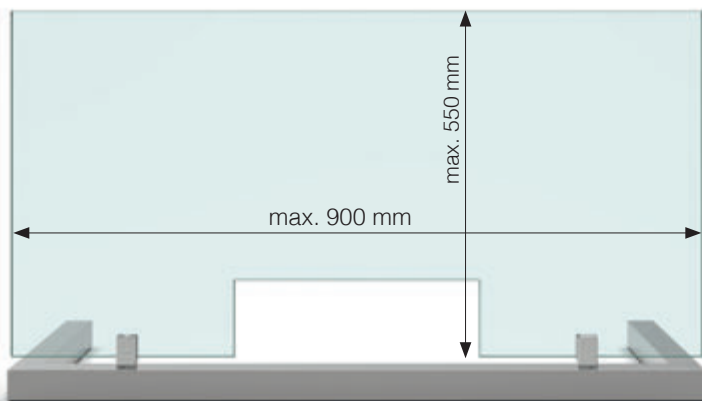

\*Bitte Glasstärke bei Bestellung angeben!  
\*Please specify glass thickness when ordering!



Art.-Nr. article no	Glasdicke glass thickness
Set-3076	4/6 mm*
Oberfläche finish	
ZN12	Alu-Optik, pulverbeschichtet Aluminium look, powder coated
ZN22	Edelstahl-optik stainless steel optic
RAL	alle Farben auf Anfrage erhältlich all colors available on request

Rohr in Edelstahl matt gebürstet | tubes are brushed stainless steel

**Set-3087: 1 Scheibe ohne Durchreiche | 1 panel without pass-through**

MADE  
IN  
GERMANY

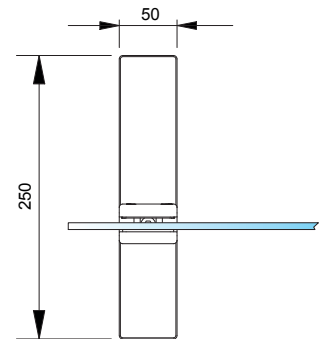
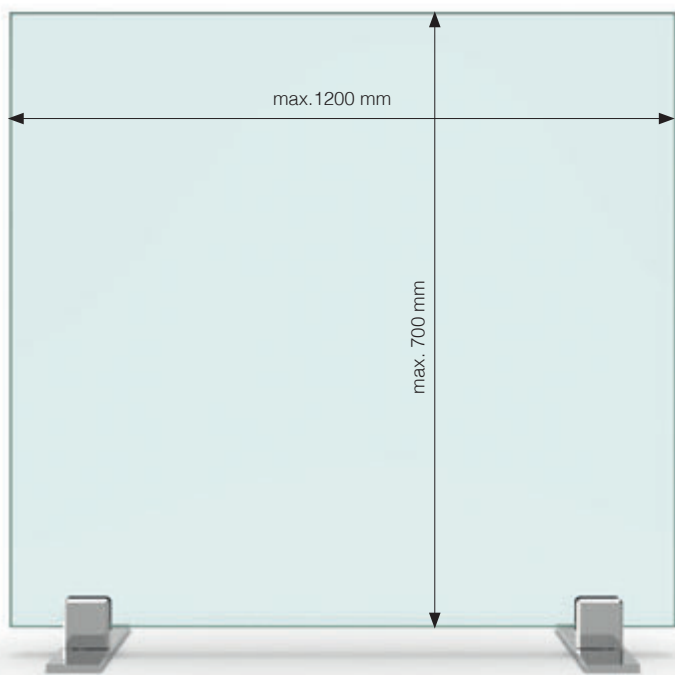

<b>Art.-Nr.</b> article no	<b>Glasdicke</b> glass thickness
Set-3087	6-12,76 mm*
<b>Oberfläche</b> finish	
ZN12	Alu-Optik, pulverbeschichtet Aluminium look, powder coated
ZN22	Edelstahl-optik stainless steel optic
RAL	alle Farben auf Anfrage erhältlich all colors available on request
VA2	Edelstahl matt gebürstet stainless steel matt brushed

Grundplatte in Edelstahl matt gebürstet | baseplate is brushed stainless steel

\*Bitte Glasstärke bei Bestellung angeben!  
\*Please specify glass thickness when ordering!

**Set-3088: 1 Scheibe mit Durchreiche | 1 panel with pass-through**

MADE  
IN  
GERMANY

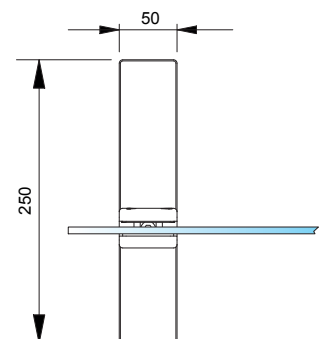
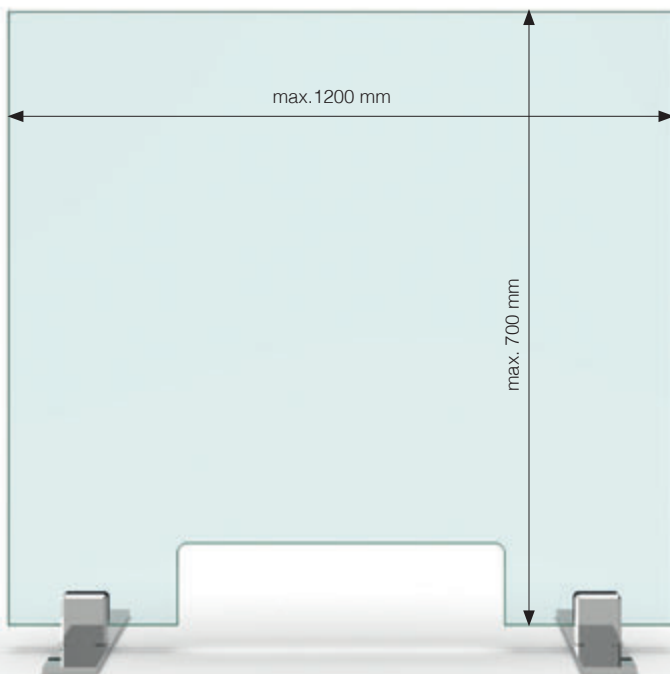

<b>Art.-Nr.</b> article no	<b>Glasdicke</b> glass thickness
Set-3088	6-12,76 mm*
<b>Oberfläche</b> finish	
ZN12	Alu-Optik, pulverbeschichtet Aluminium look, powder coated
ZN22	Edelstahl-optik stainless steel optic
RAL	alle Farben auf Anfrage erhältlich all colors available on request
VA2	Edelstahl matt gebürstet stainless steel matt brushed

Grundplatte in Edelstahl matt gebürstet | baseplate is brushed stainless steel

\*Bitte Glasstärke bei Bestellung angeben!  
\*Please specify glass thickness when ordering!



**Set-3085: 1 Scheibe ohne Durchreiche** | 1 panel without pass-through

MADE  
IN  
GERMANY

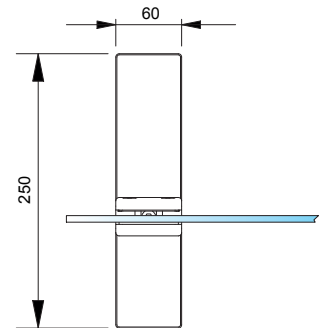
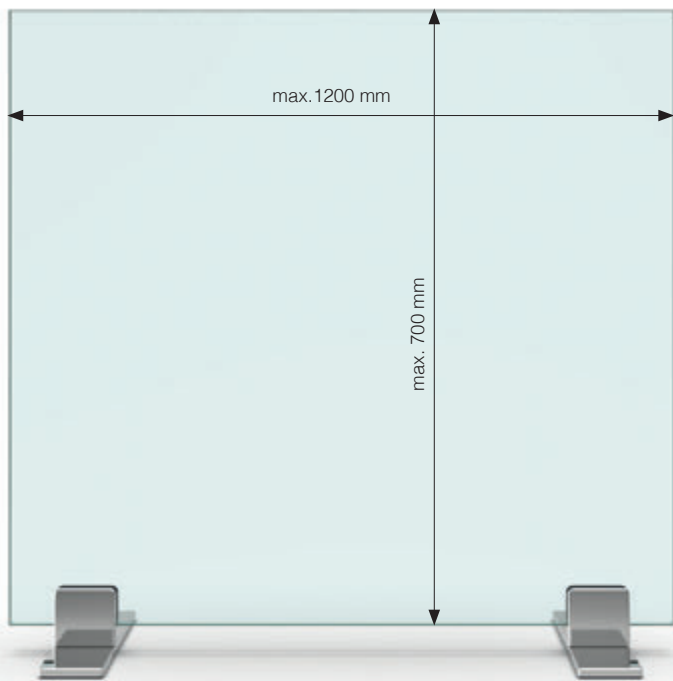

<b>Art.-Nr.</b> article no	<b>Glasdicke</b> glass thickness
Set-3085	6-12,76 mm*
<b>Oberfläche</b> finish	
ZN12	Alu-Optik, pulverbeschichtet Aluminium look, powder coated
ZN22	Edelstahl-optik stainless steel optic
RAL	alle Farben auf Anfrage erhältlich all colors available on request
VA2	Edelstahl matt gebürstet stainless steel matt brushed

Grundplatte in Edelstahl matt gebürstet | baseplate is brushed stainless steel

\*Bitte Glasstärke bei Bestellung angeben!  
\*Please specify glass thickness when ordering!

**Set-3086: 1 Scheibe mit Durchreiche** | 1 panel with pass-through

MADE  
IN  
GERMANY

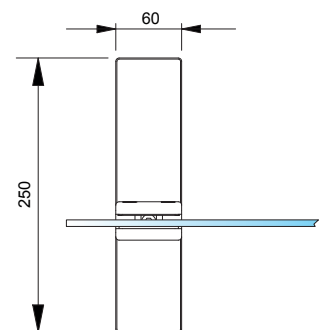
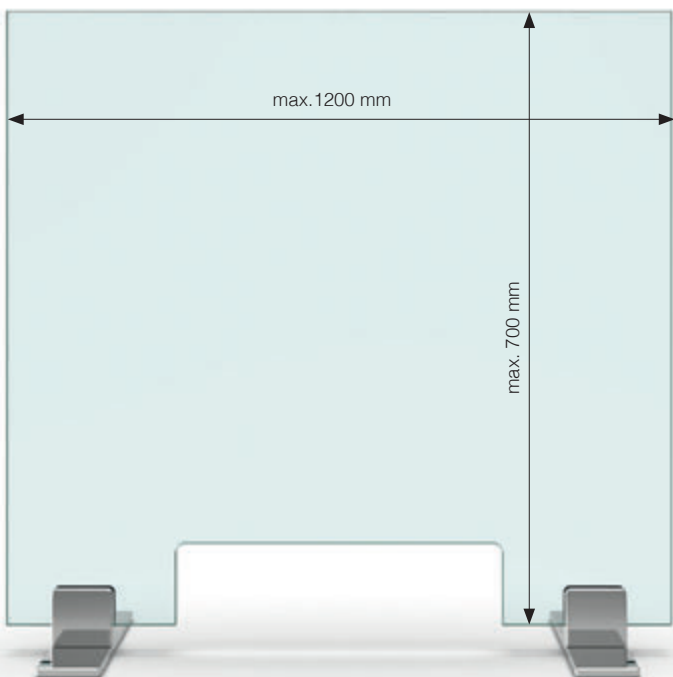

<b>Art.-Nr.</b> article no	<b>Glasdicke</b> glass thickness
Set-3086	6-12,76 mm*
<b>Oberfläche</b> finish	
ZN12	Alu-Optik, pulverbeschichtet Aluminium look, powder coated
ZN22	Edelstahl-optik stainless steel optic
RAL	alle Farben auf Anfrage erhältlich all colors available on request
VA2	Edelstahl matt gebürstet stainless steel matt brushed

Grundplatte in Edelstahl matt gebürstet | baseplate is brushed stainless steel

\*Bitte Glasstärke bei Bestellung angeben!  
\*Please specify glass thickness when ordering!

**Set-3083:** 1 Scheibe ohne Durchreiche | 1 panel without pass-through

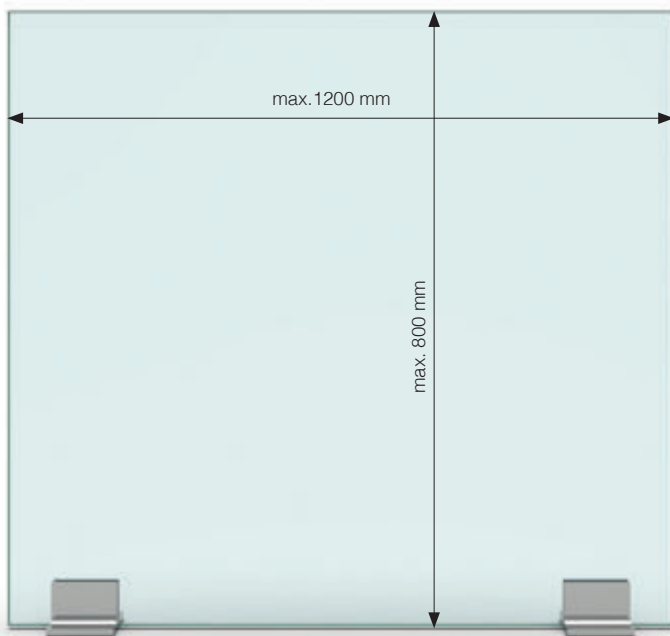

\*Bitte Glasstärke bei Bestellung angeben!  
\*Please specify glass thickness when ordering!

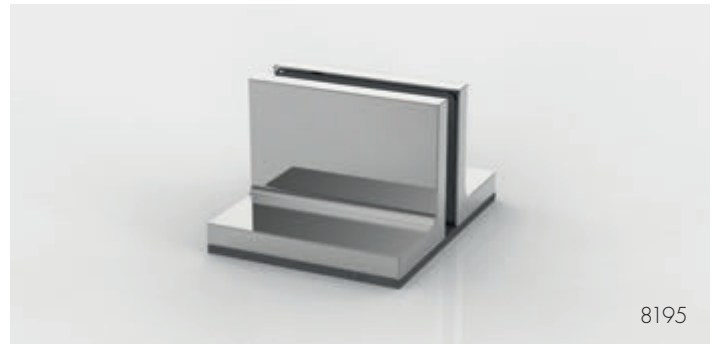

8195

Art.-Nr. article no	Glasdicke glass thickness
Set-3083	6/8/10 mm*
Oberfläche finish	
ZN5	glanzverchromt gloss chrome
ZNPVD22	Edelstahloptik stainless steel optic
ZN35	schwarz black
RAL	alle Farben auf Anfrage erhältlich all colors available on request

**Set-3084:** 1 Scheibe mit Durchreiche | 1 panel with pass-through

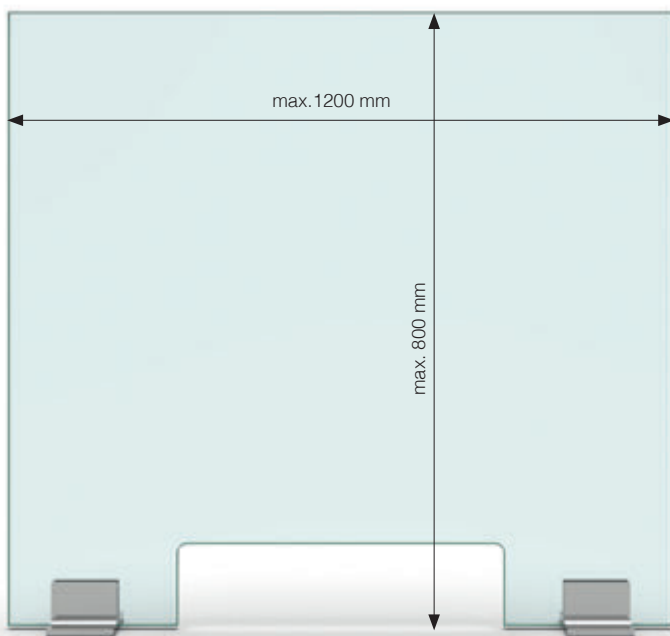

\*Bitte Glasstärke bei Bestellung angeben!  
\*Please specify glass thickness when ordering!

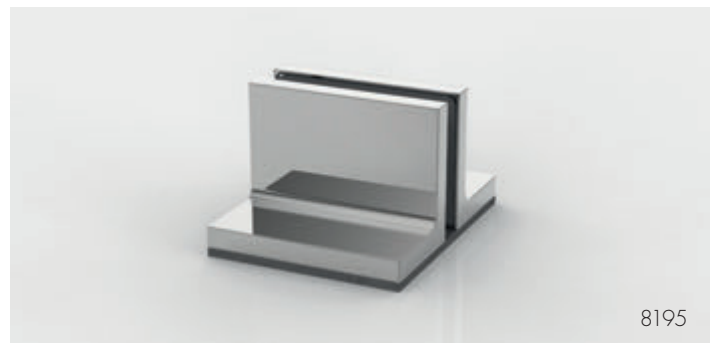

8195

Art.-Nr. article no	Glasdicke glass thickness
Set-3084	6/8/10 mm*
Oberfläche finish	
ZN5	glanzverchromt gloss chrome
ZNPVD22	Edelstahloptik stainless steel optic
ZN35	schwarz black
RAL	alle Farben auf Anfrage erhältlich all colors available on request





**Set-3089:** 1 Scheibe mit Durchreiche | 1 panel with pass-through

MADE  
IN  
GERMANY

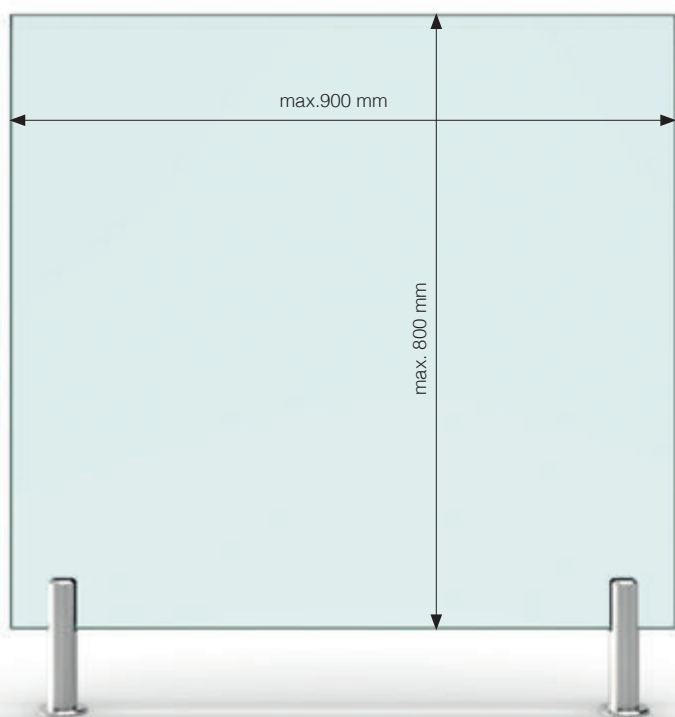

Art.-Nr. article no	Glasdicke glass thickness
Set-3089	8-12,76 mm*
Oberfläche finish	
VA	Edelstahl stainless steel

\*Bitte Glasstärke bei Bestellung angeben!  
\*Please specify glass thickness when ordering!

## Set-3074: 1 Scheibe ohne Durchreiche | 1 panel without pass-through

Lieferbar ab Sommer 2020  
available in summer 2020

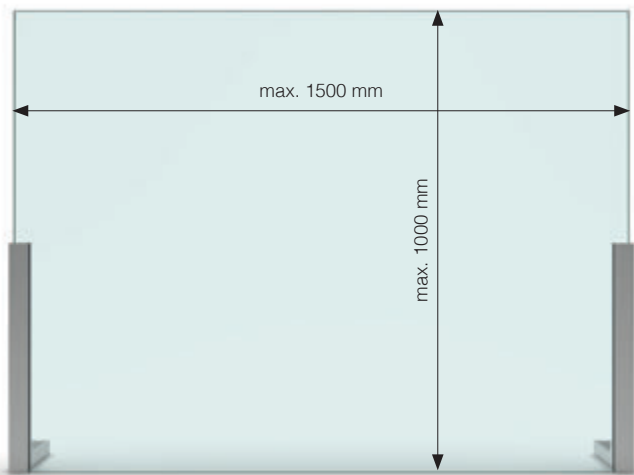

\*Bitte Glasstärke bei Bestellung angeben!  
\*Please specify glass thickness when ordering!



<b>Art.-Nr.</b> article no	<b>Glasdicke</b> glass thickness
Set-3074	6-10 mm*
<b>Oberfläche</b> finish	
MS7	glanzverchromt gloss chrome
MSPVD22	Edelstahloptik stainless steel optic
MS35	schwarz matt matt black
RAL	alle Farben auf Anfrage erhältlich all colors available on request

## Set-3090: 1 Scheibe mit Durchreiche | 1 panel with pass-through

Lieferbar ab Sommer 2020  
available in summer 2020

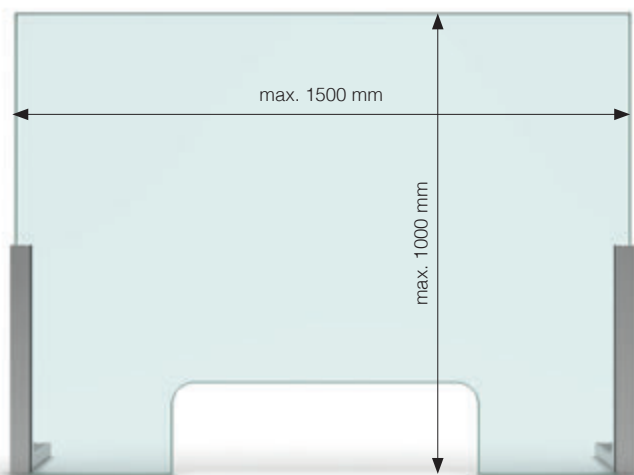

\*Bitte Glasstärke bei Bestellung angeben!  
\*Please specify glass thickness when ordering!



<b>Art.-Nr.</b> article no	<b>Glasdicke</b> glass thickness
Set-3090	6-10 mm*
<b>Oberfläche</b> finish	
MS7	glanzverchromt gloss chrome
MSPVD22	Edelstahloptik stainless steel optic
MS35	schwarz black
RAL	alle Farben auf Anfrage erhältlich all colors available on request



**Set-3063:** 1 Scheibe ohne Durchreiche | 1 panel without pass-through

MADE  
IN  
GERMANY

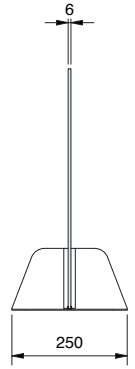
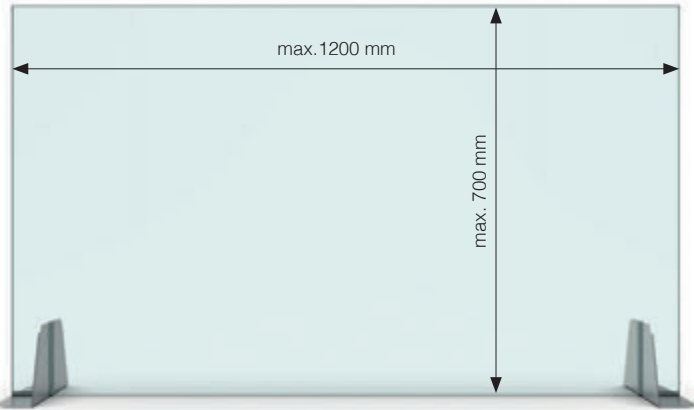

\*Bitte Glasstärke bei Bestellung angeben!  
\*Please specify glass thickness when ordering!

<b>Art.-Nr.</b> article no	<b>Glasdicke</b> glass thickness
Set-3063	6 mm*
<b>Oberfläche</b> finish	
VA2	Edelstahl matt gebürstet stainless steel matt brushed

**Set-3062:** 1 Scheibe mit Durchreiche | 1 panel with pass-through

MADE  
IN  
GERMANY

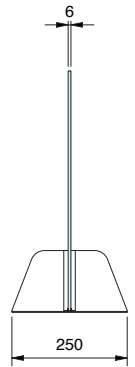
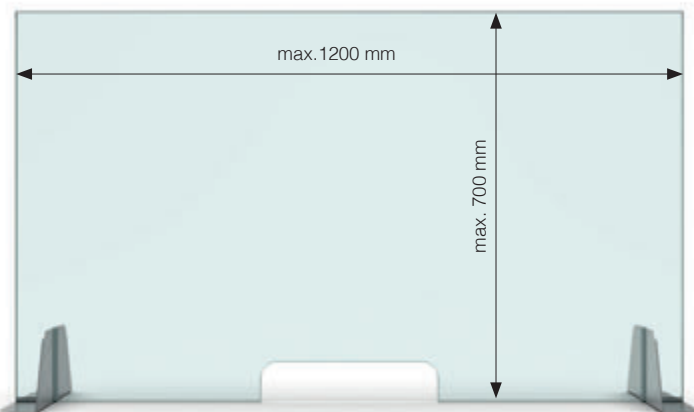

\*Bitte Glasstärke bei Bestellung angeben!  
\*Please specify glass thickness when ordering!

<b>Art.-Nr.</b> article no	<b>Glasdicke</b> glass thickness
Set-3062	6 mm*
<b>Oberfläche</b> finish	
VA2	Edelstahl matt gebürstet stainless steel matt brushed

**Set-3099:** 2 Scheiben (90°) ohne Durchreiche | 2 panels (90°) without pass-through

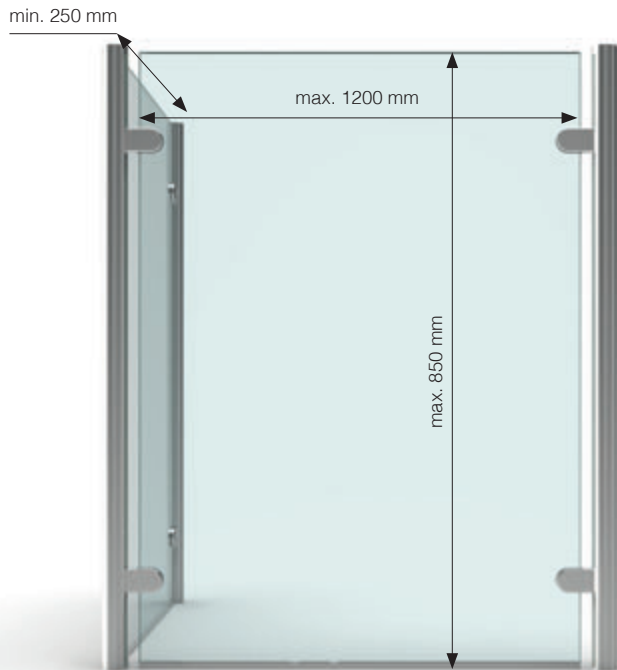

<b>Art.-Nr.</b> article no	<b>Glasdicke</b> glass thickness
Set-3099	4/6 mm*
<b>Oberfläche</b> finish	
ZN12	Alu-Optik, pulverbeschichtet Aluminium look, powder coated
ZN22	Edelstahloptik stainless steel optic
RAL	alle Farben auf Anfrage erhältlich all colors available on request

Rohr in Edelstahl matt gebürstet | tubes are brushed stainless steel

\*Bitte Glasstärke bei Bestellung angeben! U-Profile können optional mitgeliefert werden. optional: Pfosten in A2 oder A4 erhältlich  
\*Please specify glass thickness when ordering! U profiles can be supplied optionally. optional: posts are available in 304 or 316 stainless steel

**Set-3098:** 3 Scheiben (90°) ohne Durchreiche | 3 panels (90°) without pass-through

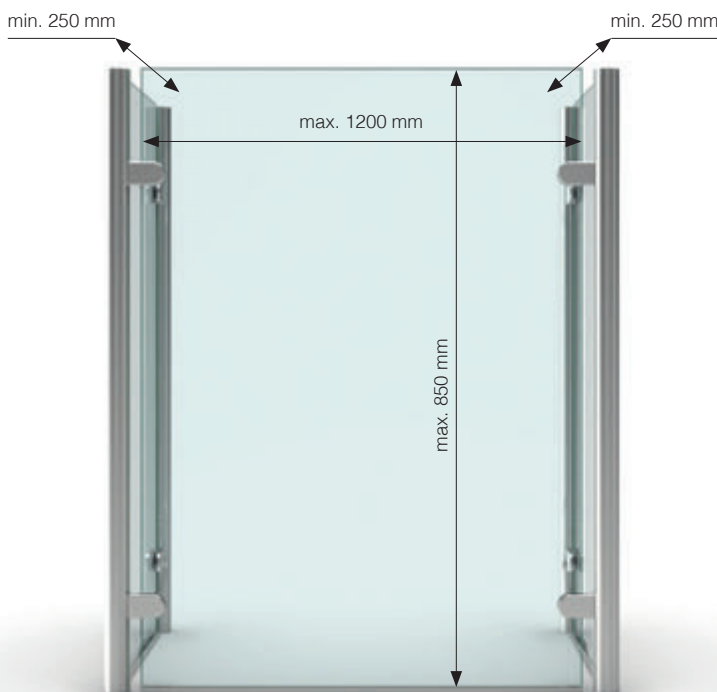

<b>Art.-Nr.</b> article no	<b>Glasdicke</b> glass thickness
Set-3098	4/6 mm*
<b>Oberfläche</b> finish	
ZN12	Alu-Optik, pulverbeschichtet Aluminium look, powder coated
ZN22	Edelstahloptik stainless steel optic
RAL	alle Farben auf Anfrage erhältlich all colors available on request

Rohr in Edelstahl matt gebürstet | tubes are brushed stainless steel

\*Bitte Glasstärke bei Bestellung angeben! U-Profile können optional mitgeliefert werden. optional: Pfosten in A2 oder A4 erhältlich  
\*Please specify glass thickness when ordering! U profiles can be supplied optionally. optional: posts are available in 304 or 316 stainless steel



**Set-3097: 2 Scheiben (90°) ohne Durchreiche | 2 panels (90°) without pass-through**

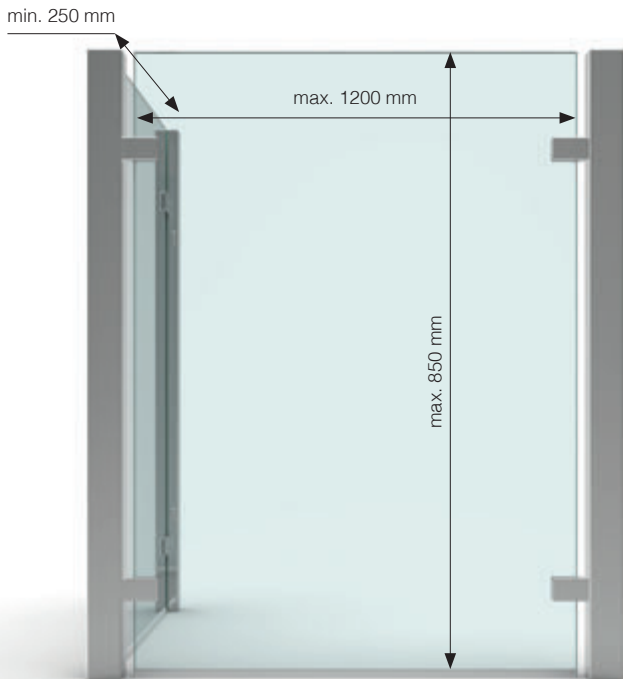

<b>Art.-Nr.</b> article no	<b>Glasdicke</b> glass thickness
Set-3097	4/6 mm*
<b>Oberfläche</b> finish	
ZN12	Alu-Optik, pulverbeschichtet Aluminium look, powder coated
ZN22	Edelstahloptik stainless steel optic
RAL	alle Farben auf Anfrage erhältlich all colors available on request

Rohr in Edelstahl matt gebürstet | tubes are brushed stainless steel

\*Bitte Glasstärke bei Bestellung angeben! U-Profile können optional mitgeliefert werden. optional: Pfosten in A2 oder A4 erhältlich  
\*Please specify glass thickness when ordering! U profiles can be supplied optionally. optional: posts are available in 304 or 316 stainless steel

**Set-3096: 3 Scheiben (90°) ohne Durchreiche | 3 panels (90°) without pass-through**

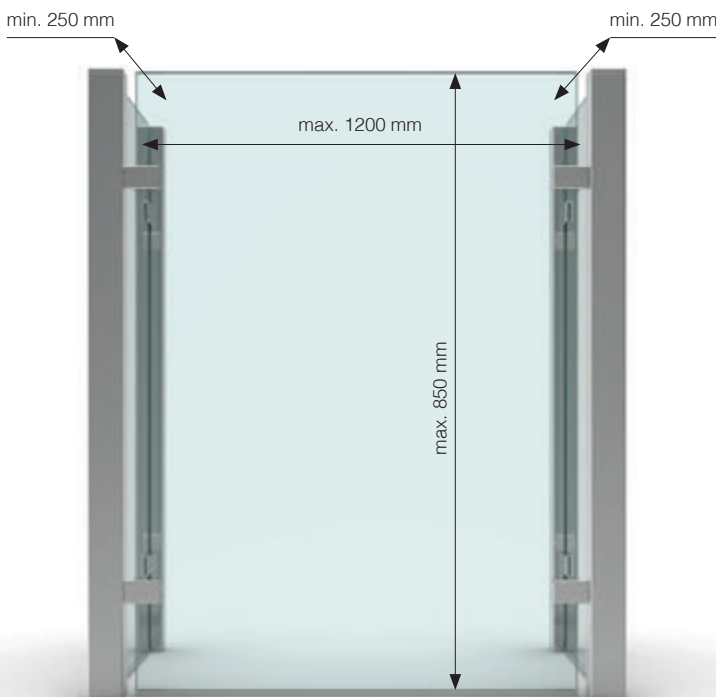

<b>Art.-Nr.</b> article no	<b>Glasdicke</b> glass thickness
Set-3096	4/6 mm*
<b>Oberfläche</b> finish	
ZN12	Alu-Optik, pulverbeschichtet Aluminium look, powder coated
ZN22	Edelstahloptik stainless steel optic
RAL	alle Farben auf Anfrage erhältlich all colors available on request

Rohr in Edelstahl matt gebürstet | tubes are brushed stainless steel

\*Bitte Glasstärke bei Bestellung angeben! U-Profile können optional mitgeliefert werden. optional: Pfosten in A2 oder A4 erhältlich  
\*Please specify glass thickness when ordering! U profiles can be supplied optionally. optional: posts are available in 304 or 316 stainless steel

**Set-3094:** 2 Scheiben (90°) ohne Durchreiche | 2 panels (90°) without pass-through

MADE  
IN  
GERMANY



Art.-Nr. article no	Glasdicke glass thickness
Set-3094	6-10,76 mm*
Oberfläche finish	
VA2	Edelstahl matt gebürstet stainless steel matt brushed

\*Bitte Glasstärke bei Bestellung angeben! U-Profile können optional mitgeliefert werden.  
optional: Pfosten in A2 oder A4 erhältlich  
\*Please specify glass thickness when ordering! U profiles can be supplied optionally. optional:  
posts are available in 304 or 316 stainless steel

**Set-3095:** 3 Scheiben (90°) ohne Durchreiche | 3 panels (90°) without pass-through

MADE  
IN  
GERMANY

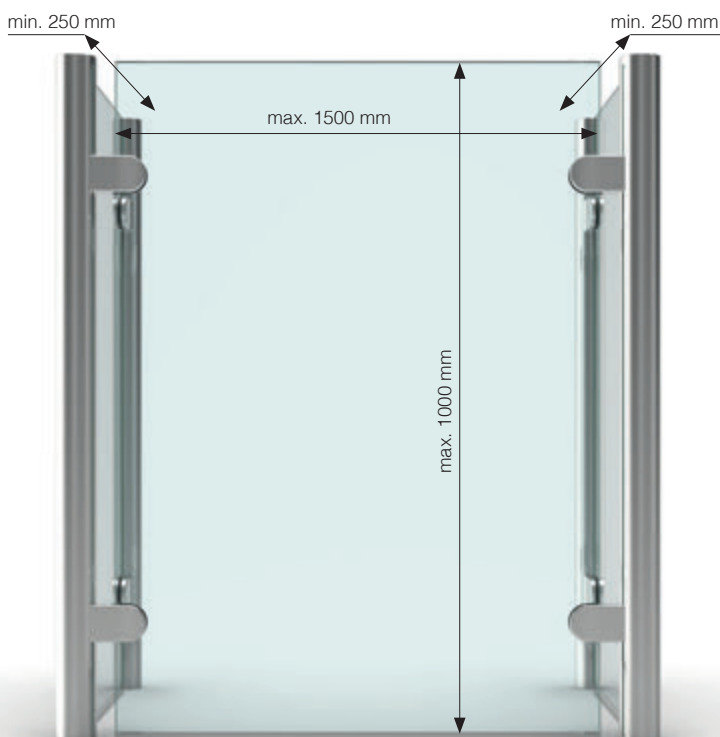

Art.-Nr. article no	Glasdicke glass thickness
Set-3095	6-10,76 mm*
Oberfläche finish	
VA2	Edelstahl matt gebürstet stainless steel matt brushed

\*Bitte Glasstärke bei Bestellung angeben! U-Profile können optional mitgeliefert werden.  
optional: Pfosten in A2 oder A4 erhältlich  
\*Please specify glass thickness when ordering! U profiles can be supplied optionally. optional:  
posts are available in 304 or 316 stainless steel



Zubehör für Sets mit Pfosten | accessories for sets with post



**LOCTITE® 638 Spezialkleber**

LOCTITE® 638 Special adhesive

- |  |   |
|--|---|
| <input type="checkbox"/> Kurze Trocknung | <input type="checkbox"/> Short bonding time |
| <input type="checkbox"/> Hohe Festigkeit | <input type="checkbox"/> High strength      |
| <input type="checkbox"/> DVGW-geprüft    | <input type="checkbox"/> DVGW-Tested        |

**Art.-Nr.**

**Inhalt**

Art. no.

Content

1023300CTP

10-ml-Flasche | 10-ml-Bottle

1023310CTP

50-ml-Flasche | 50-ml-Bottle



**Art.-Nr.**

article no

4820VA



Sicherheitsstift für Set-3085/3086  
safety stud for Set-3085/3086

Bohrungen für Sicherheitsstifte sind in den Glaszeichnungen nicht berücksichtigt. Bitte bei Bestellung erfragen.  
Holes for safety studs are not shown in the glass drawings, if desired, please enquire when ordering.

Set-3092: 3 Scheiben (90°) ohne Durchreiche | 3 panels (90°) without passthrough

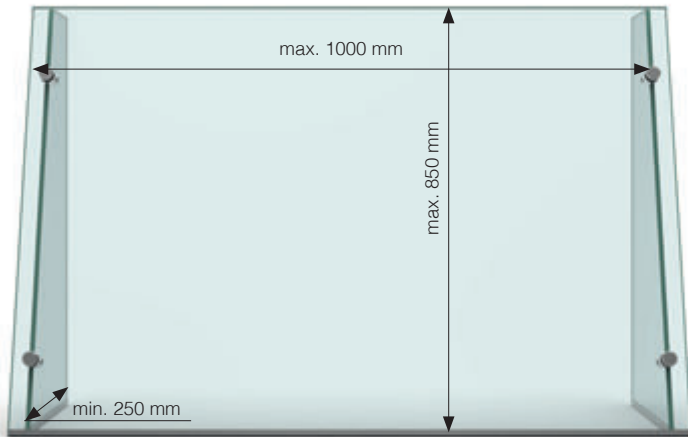

2877



2879

Art.-Nr. article no	Glasdicke glass thickness
Set-3092	6-10 mm*
Oberfläche finish	
ZN5	glanzverchromt gloss chrome
ZN22	Edelstahloptik stainless steel optic
RAL	alle Farben auf Anfrage erhältlich all colors available on request

\*Bitte Glasstärke bei Bestellung angeben! U-Profile können optional mitgeliefert werden.  
\*Please specify glass thickness when ordering! U profiles can be supplied optionally.





**Set-3081: 3 Scheiben (135°) mit Durchreiche** | 3 panels (135°) with pass-through

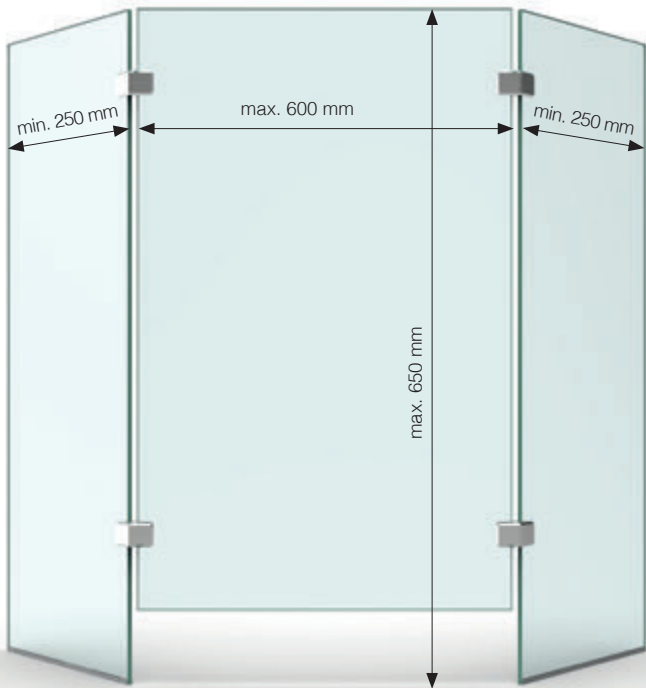

Art.-Nr. article no	Glasdicke glass thickness
Set-3081	5–8 mm*
Oberfläche finish	
ZN5	glanzverchromt gloss chrome
ZN22	Edelstahloptik stainless steel optic
RAL	alle Farben auf Anfrage erhältlich all colors available on request

\*Bitte Glasstärke bei Bestellung angeben! U-Profile können optional können optional mitgeliefert werden.  
\*Please specify glass thickness when ordering! U profiles can be supplied optionally.

**Set-3082: 3 Scheiben (90°) mit Durchreiche** | 3 panels (90°) with pass-through



Art.-Nr. article no	Glasdicke glass thickness
Set-3082	5–8 mm*
Oberfläche finish	
ZN5	glanzverchromt gloss chrome
ZN22	Edelstahloptik stainless steel optic
RAL	alle Farben auf Anfrage erhältlich all colors available on request

\*Bitte Glasstärke bei Bestellung angeben! U-Profile können optional können optional mitgeliefert werden.  
\*Please specify glass thickness when ordering! U profiles can be supplied optionally.

**Set-3093: 3 Scheiben mit Durchreiche** | panel with pass-through

MADE  
IN  
GERMANY

Lieferbar ab Sommer 2020  
available in summer 2020

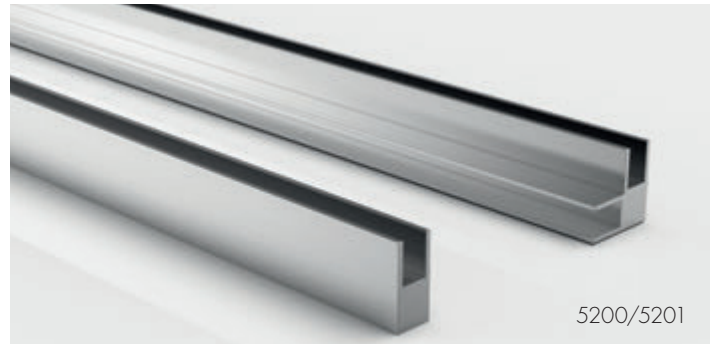
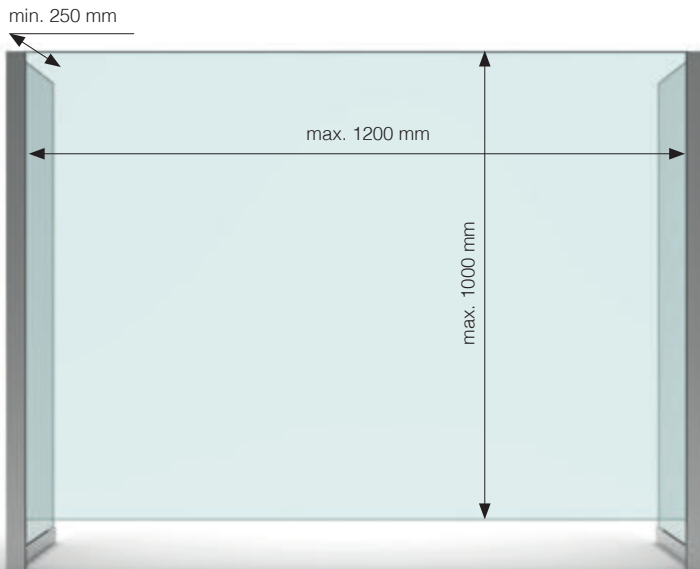

Art.-Nr. article no	Glasdicke glass thickness
Set-3093	≤ 8 mm*
Oberfläche finish	
E6EV1	Alu-Optik, silberfarbig eloxiert Aluminium look, anodised silver
RAL	alle Farben auf Anfrage erhältlich all colors available on request

\*Bitte Glasstärke bei Bestellung angeben!  
\*Please specify glass thickness when ordering!

**Set-3075: 3 Scheiben (135°) mit Durchreiche** | 3 panels (135°) with pass-through

MADE  
IN  
GERMANY

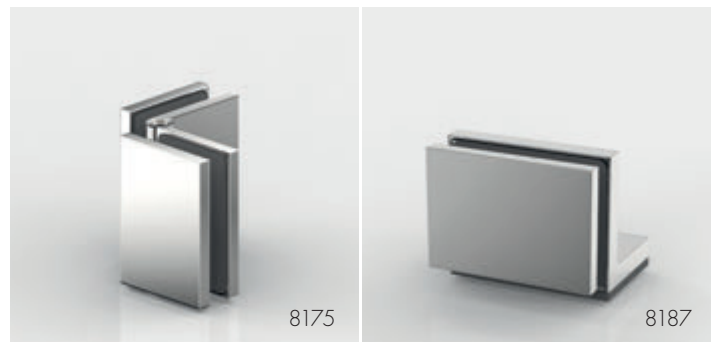
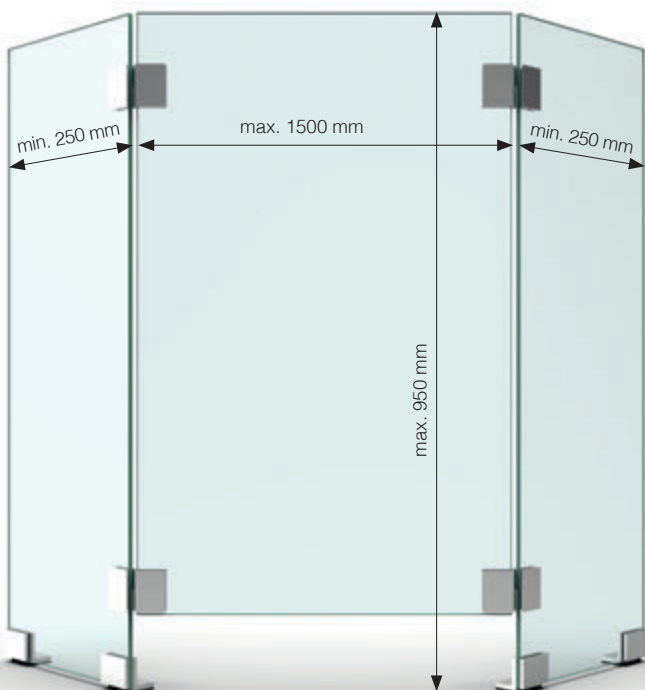

Art.-Nr. article no	Glasdicke glass thickness
Set-3075	6/8/10 mm*
Oberfläche finish	
ZN5	glanzverchromt gloss chrome
ZNPVD22	Edelstahloptik stainless steel optic
ZN35	schwarz black
RAL	alle Farben auf Anfrage erhältlich all colors available on request

\*Bitte Glasstärke bei Bestellung angeben!  
\*Please specify glass thickness when ordering!

Glasbearbeitungen | glass processing

Art.-Nr. article no	Glasdicke glass thickness
Glas-3078-V Glas zu Set-3078 glass for Set-3078	4/6 mm*

Seite | page 04

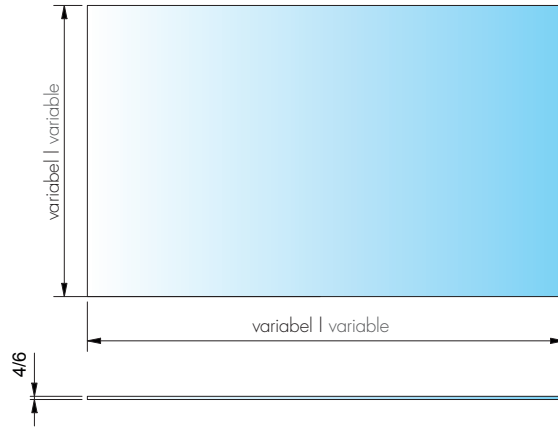

Art.-Nr. article no	Glasdicke glass thickness
Glas-3079-V Glas zu Set-3079 glass for Set-3079	4/6 mm*

Seite | page 04

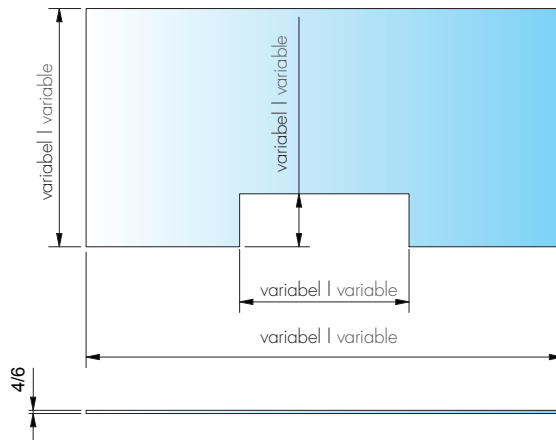

Art.-Nr. article no	Glasdicke glass thickness
Glas-3078-V Glas zu Set-3077 glass for Set-3077	4/6 mm*

Seite | page 05

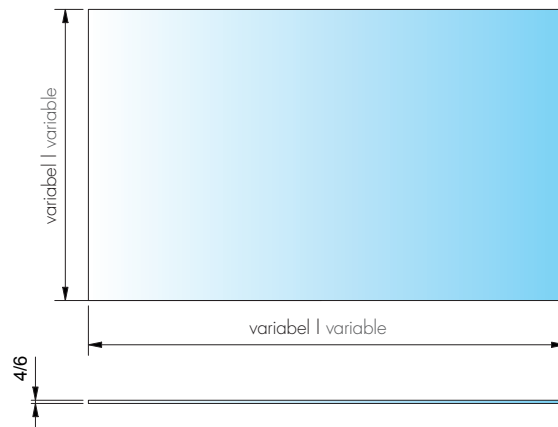

\*Bitte Glasstärke bei Bestellung angeben!  
\*Please specify glass thickness when ordering!

Glasbearbeitungen | glass processing

Art.-Nr. article no	Glasdicke glass thickness
Glas-3079-V Glas zu Set-3076 glass for Set-3076	4/6 mm*

Seite | page 05

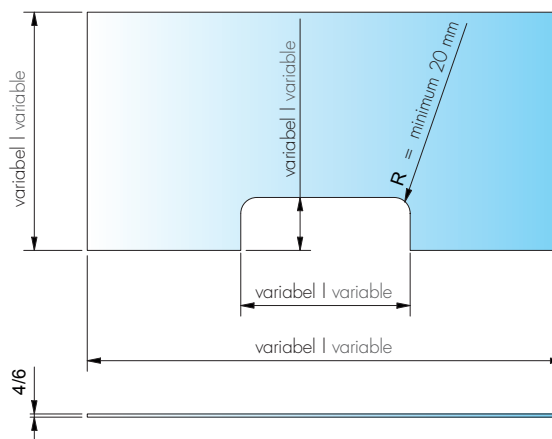

Art.-Nr. article no	Glasdicke glass thickness
Glas-3087-V Glas zu Set-3087 glass for Set-3087	6-12,76 mm*

Seite | page 06

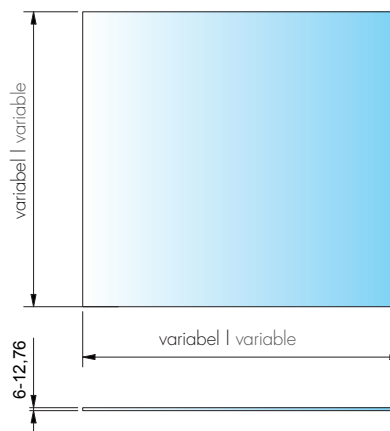

Art.-Nr. article no	Glasdicke glass thickness
Glas-3088-V Glas zu Set-3088 glass for Set-3088	6-12,76 mm*

Seite | page 06

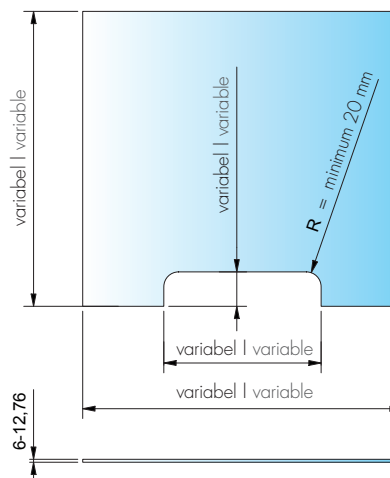

\*Bitte Glasstärke bei Bestellung angeben!  
\*Please specify glass thickness when ordering!

Glasbearbeitungen | glass processing

Art.-Nr. article no	Glasdicke glass thickness
Glas-3087-V Glas zu Set-3085 glass for Set-3085	6-12,76 mm*

Seite | page 07

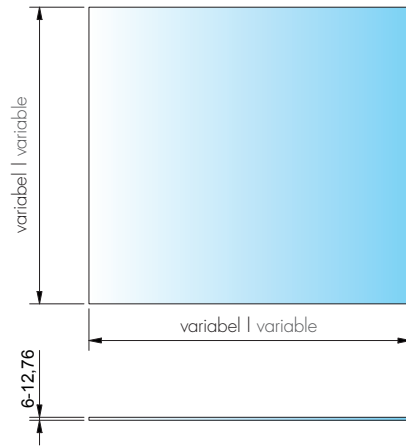

Art.-Nr. article no	Glasdicke glass thickness
Glas-3088-V Glas zu Set-3086 glass for Set-3086	6-12,76 mm*

Seite | page 07

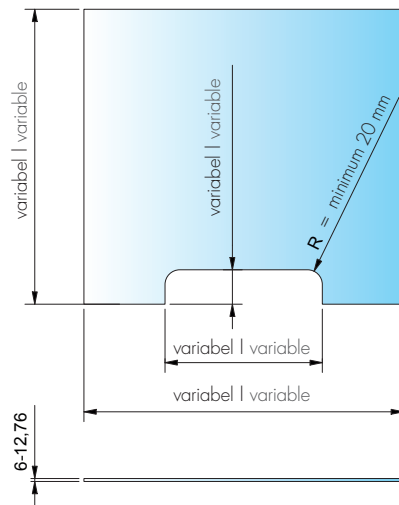

Art.-Nr. article no	Glasdicke glass thickness
Glas-3083-V Glas zu Set-3083 glass for Set-3083	6/8/10 mm*

Seite | page 08

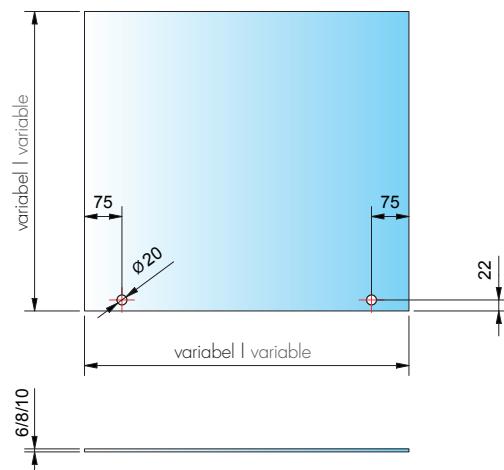

\*Bitte Glasstärke bei Bestellung angeben!  
\*Please specify glass thickness when ordering!

Glasbearbeitungen | glass processing

Art.-Nr. article no	Glasdicke glass thickness
Glas-3084-V Glas zu Set-3084 glass for Set-3084	6/8/10 mm*

Seite | page 08

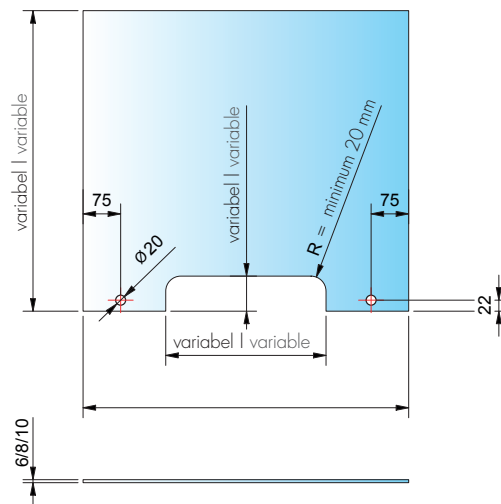

Art.-Nr. article no	Glasdicke glass thickness
Glas-3089-V Glas zu Set-3089 glass for Set-3089	8-12,76 mm*

Seite | page 09

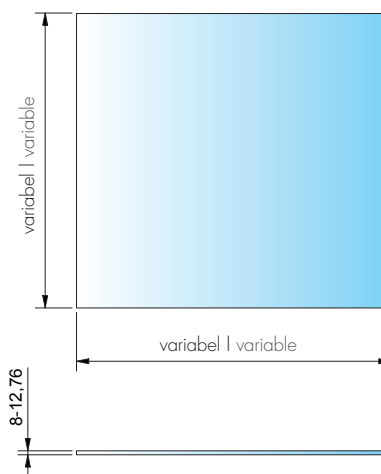

Art.-Nr. article no	Glasdicke glass thickness
Glas-3074-V Glas zu Set-3074 glass for Set-3074	6-10 mm*

Seite | page 10

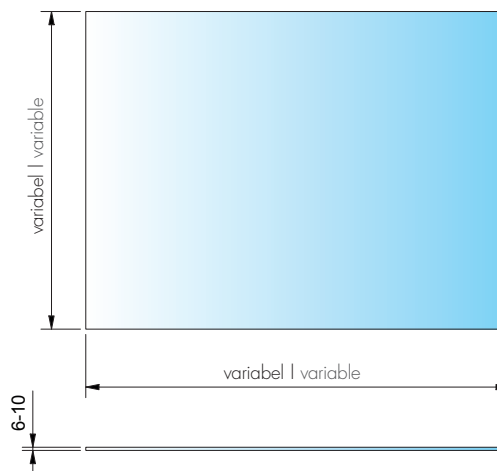

\*Bitte Glasstärke bei Bestellung angeben!  
\*Please specify glass thickness when ordering!

Glasbearbeitungen | glass processing

Art.-Nr. article no	Glasdicke glass thickness
Glas-3090-V Glas zu Set-3090 glass for Set-3090	6-10 mm*

Seite | page 10

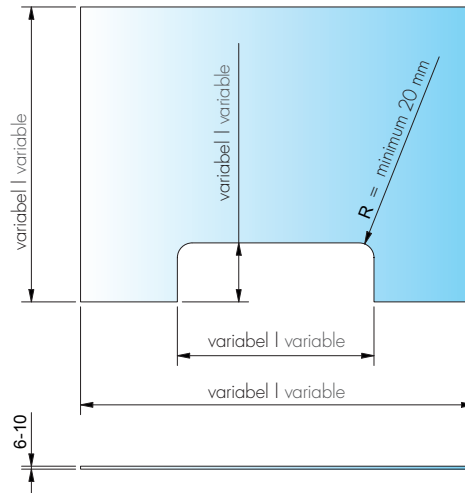

Art.-Nr. article no	Glasdicke glass thickness
Glas-3063-V Glas zu Set-3063 glass for Set-3063	6 mm*

Seite | page 11

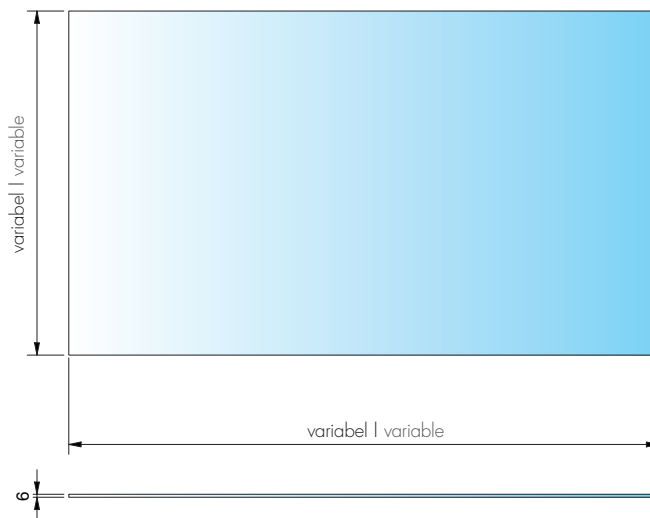

Art.-Nr. article no	Glasdicke glass thickness
Glas-3062-V Glas zu Set-3062 glass for Set-3062	6 mm*

Seite | page 11

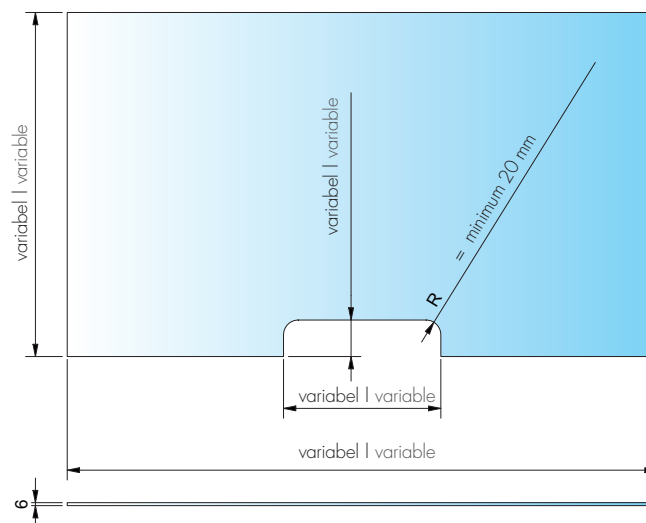

\*Bitte Glasstärke bei Bestellung angeben!  
\*Please specify glass thickness when ordering!

Glasbearbeitungen | glass processing

Art.-Nr. article no	Glasdicke glass thickness
Glas-3098-1-V Glas zu Set-3098	4/6 mm*
Glas-3098-2-V glass for Set-3098	

Seite | page 12

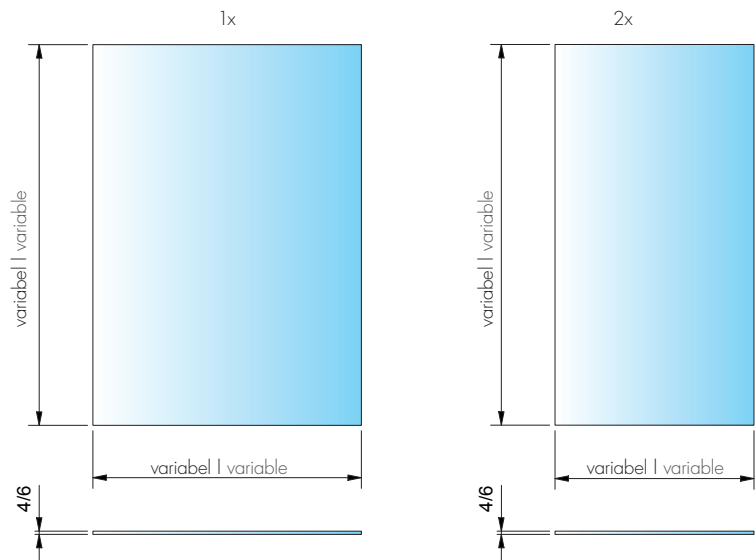

Art.-Nr. article no	Glasdicke glass thickness
Glas-3098-1-V Glas zu Set-3099	4/6 mm*
Glas-3098-2-V glass for Set-3099	

Seite | page 12

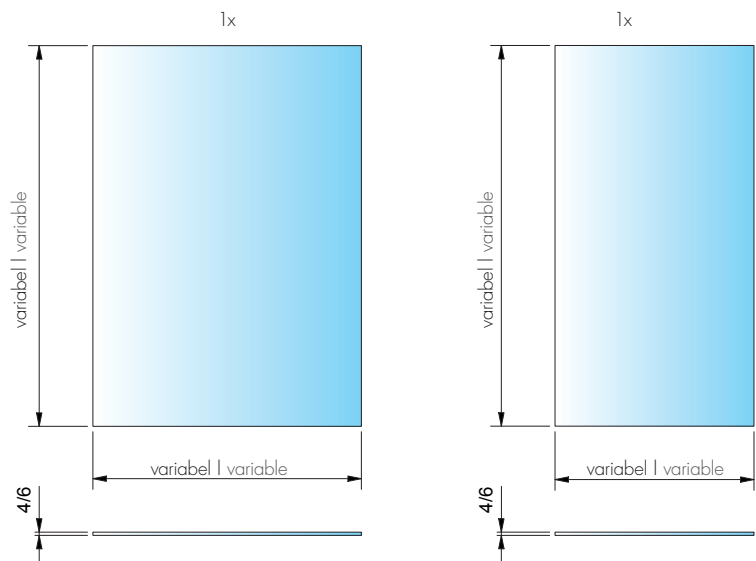

Art.-Nr. article no	Glasdicke glass thickness
Glas-3098-1-V Glas zu Set-3096	4/6 mm*
Glas-3098-2-V glass for Set-3096	

Seite | page 13

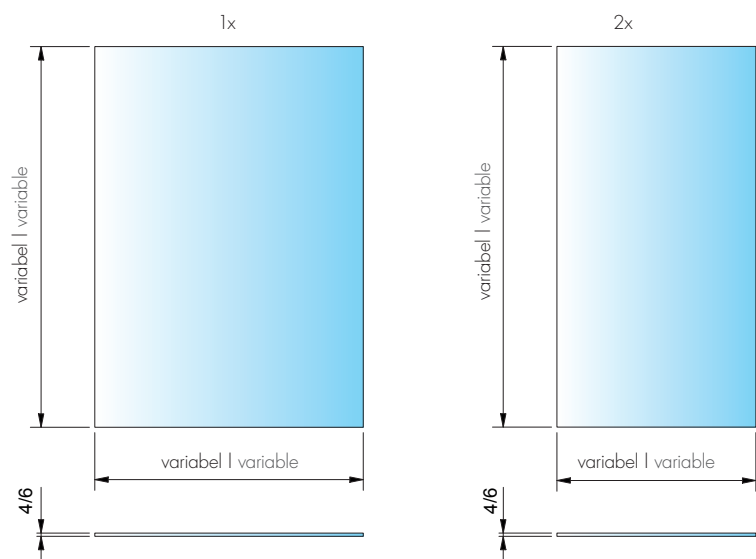

\*Bitte Glasstärke bei Bestellung angeben!  
\*Please specify glass thickness when ordering!



Glasbearbeitungen | glass processing

Art.-Nr. article no	Glasdicke glass thickness
Glas-3098-1-V Glas zu Set-3097	4/6 mm*
Glas-3098-2-V glass for Set-3097	

Seite | page 13

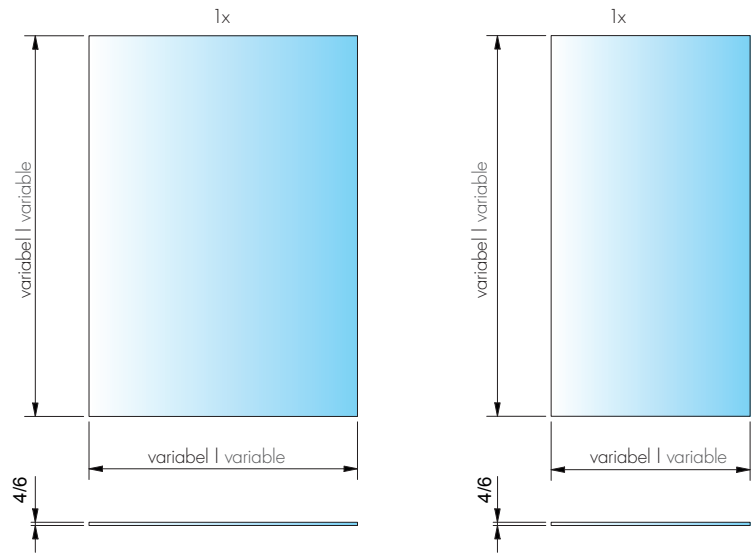

Art.-Nr. article no	Glasdicke glass thickness
Glas-3094-1-V Glas zu Set-3094	6-10,76 mm*
Glas-3094-2-V glass for Set-3094	

Seite | page 14

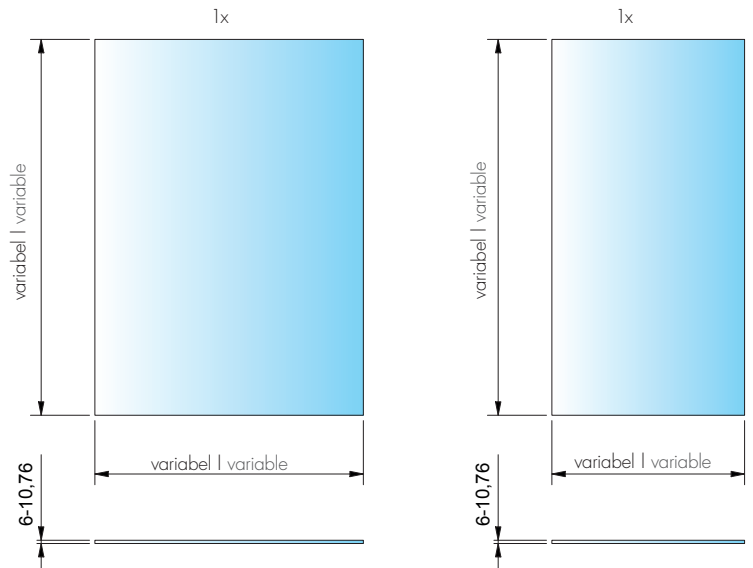

Art.-Nr. article no	Glasdicke glass thickness
Glas-3094-1-V Glas zu Set-3095	6-10,76 mm*
Glas-3094-2-V glass for Set-3095	

Seite | page 14

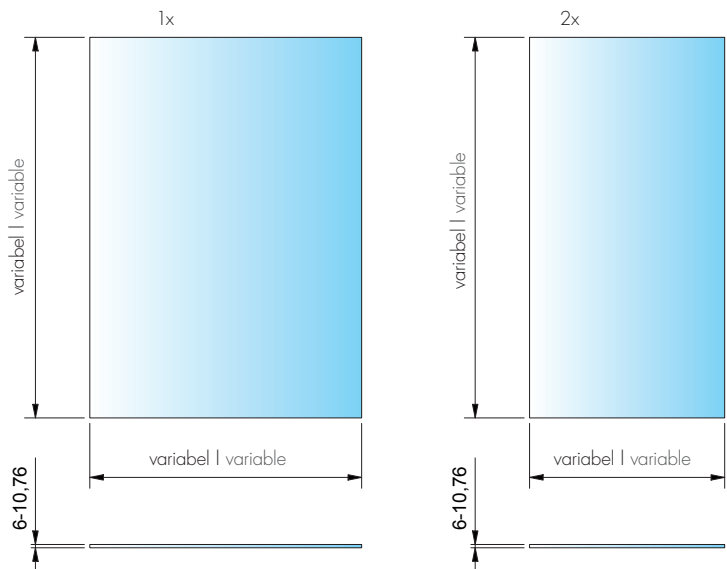

\*Bitte Glasstärke bei Bestellung angeben!  
\*Please specify glass thickness when ordering!

Glasbearbeitungen | glass processing

Art.-Nr. article no	Glasdicke glass thickness
Glas-3092-1-V	Glas zu Set-3092 6-10 mm*
Glas-3092-2-V	glass for Set-3092

Seite | page 16

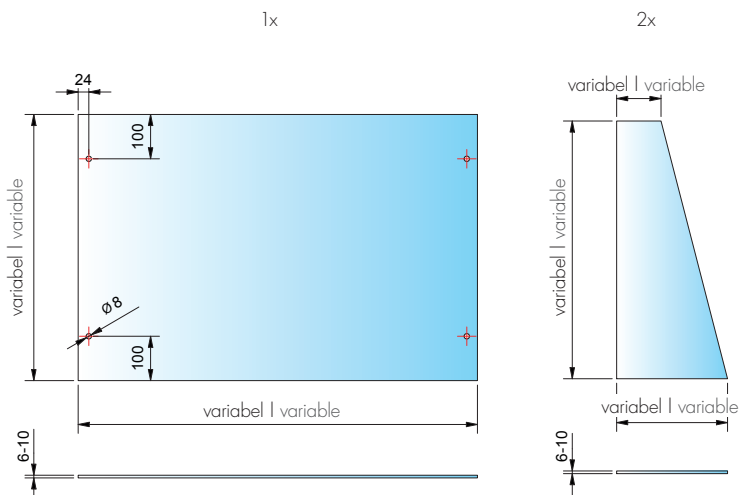

Art.-Nr. article no	Glasdicke glass thickness
Glas-3081-1-V	Glas zu Set-3081 5-8 mm*
Glas-3081-2-V	glass for Set-3081

Seite | page 17

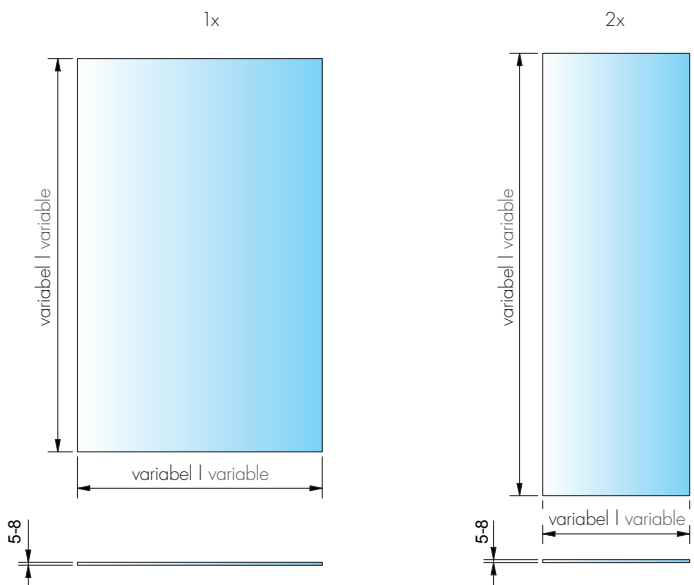

Art.-Nr. article no	Glasdicke glass thickness
Glas-3081-1-V	Glas zu Set-3082 5-8 mm*
Glas-3081-2-V	glass for Set-3082

Seite | page 17

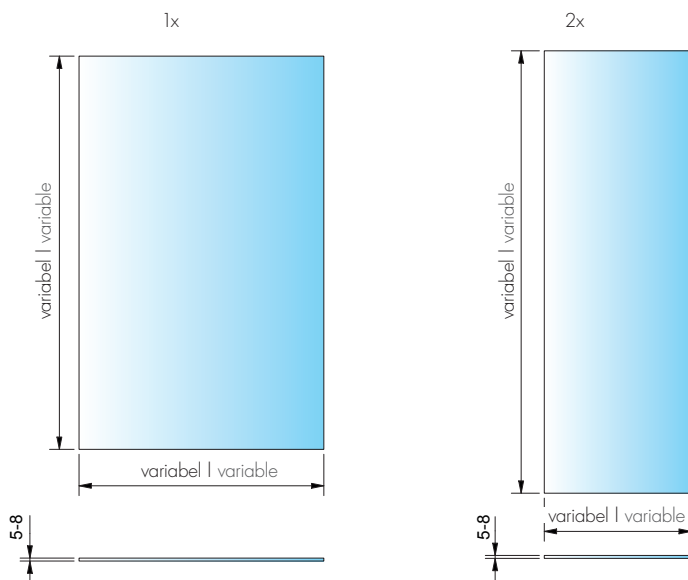

\*Bitte Glasstärke bei Bestellung angeben!  
\*Please specify glass thickness when ordering!

Glasbearbeitungen | glass processing

Art.-Nr. article no	Glasdicke glass thickness
Glas-3093-1-V	Glas zu Set-3093 $\leq 8$ mm*
Glas-3093-2-V	glass for Set-3093

Seite | page 18

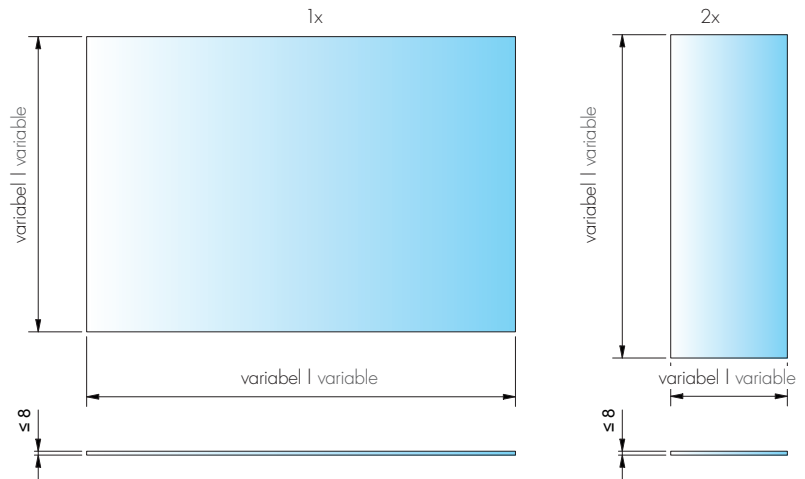

Art.-Nr. article no	Glasdicke glass thickness
Glas-3075-1-V	Glas zu Set-3075 6/8/10 mm*
Glas-3075-2-V	glass for Set-3075

Seite | page 18

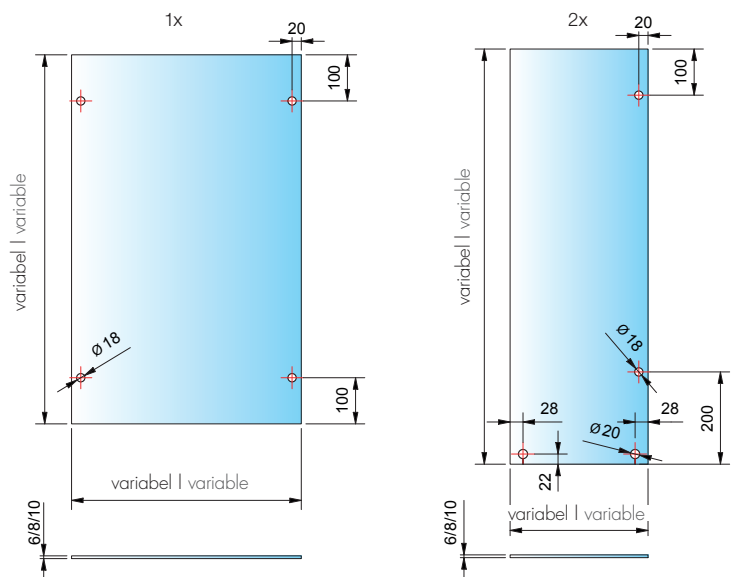

Art.-Nr. P00-18-24  
Alle Bilder, technische Zeichnungen und deren Beschreibungen sind urheberrechtlich geschütztes Eigentum der Pauli + Sohn GmbH. Technische Maßangaben innerhalb des Kataloges sind unverbindlich. Konstruktionsänderungen sind vorbehalten. Bitte beachten Sie unsere Schutzrechte. Für Druckfehler und Irrtümer, die bei der Herstellung unterlaufen sind, ist jede Haftung ausgeschlossen.

www.pauli.de

Technischer Stand: April 2020

art.-no. P00-18-24  
All images, technical drawings and descriptions are copyrighted property of the Pauli + Sohn GmbH. Technical measurements within the catalog are not binding and are subject to change. Any liability for printing errors which have occurred during the preparing of this brochure is excluded.

www.pauli.de

technical status: April 2020



**Glasbau Heckmann**

Nachfolger GmbH

Industriestr. 51

31275 Lehrte

Tel: +049 (5132) 87 340 0

+049 (511) 58 56 56

E-Mail: [glas@glasbau-heckmann.de](mailto:glas@glasbau-heckmann.de)

Webseite: [www.glasbau-heckmann.de](http://www.glasbau-heckmann.de)